



CREATIVE AWL
**ORIGINAL
PATTERNS**



Crossbody Bag



 **YouTube**
VIDEO TUTORIAL

**EASY TO
PRINT**
PDF >>>>
PATTERN

LET'S GO!

• & don't forget check out our free patterns!



1



PRINT THE PATTERN

- Open your pattern in Adobe Acrobat Reader, or any web browser.
- Every page has a measure - check does it fit.
- Every printed page **MUST HAVE** a border around! If doesn't - move paper left/ right and print again

2



FOLLOW VIDEO INSTRUCTIONS

- Video tutorial:
<https://youtu.be/NcZPJZ9fYcg>
- Cutting patterns:
https://www.youtube.com/watch?v=2TNUI_TIk64



3



GIVE A SMILE TO OTHER PEOPLE !

- Give a ready product to you family or friend.
Give them a smile :)))
- Also Check www.CreativeAwl.com for more patterns

4



JOIN OUR FB GROUP

- Go there to share your work. Also get more DIY&ideas. We will support you & answer all questions.
<https://www.facebook.com/groups/CreativeAwlPatterns/>



YOU NEED

MATERIALS

- AROUND 0.25SQ METERS (3 SQFT) OF 1.6MM (4OZ) LEATHER
- A ZIPPER
- WAXED THREAD (PREFERABLY 0.8MM)

TOOLS

- SHARP KNIFE
- 1.2 - 1.5 MM HOLE PUNCHER / PRICKING IRONS OR AWL
- HAMMER
- 2 NEEDLES
- PAPER TAPE
- A HOME PRINTER

SHARE YOUR WORK

<https://www.facebook.com/groups/CreativeAwlPatterns>

Cross body bag:

pages 4 - 13

-The number in the circle shows which holes are to be connected. Example: ①

-Numbers 1, 2, 3 (...) without a circle indicate where the piece lies in the overview drawing.



2

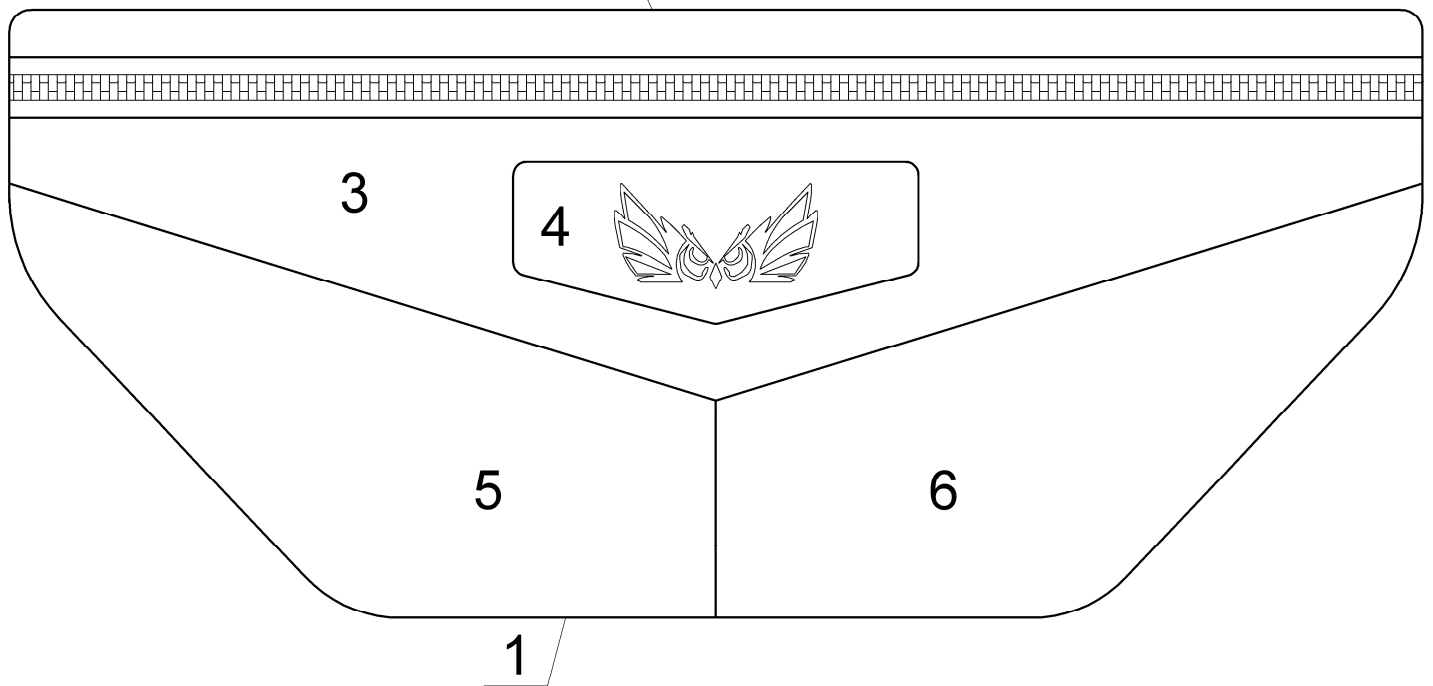

Sketch drawing

Leather needed for a Cross body bag: about 0.25 m2

410 mm (16.4 in)

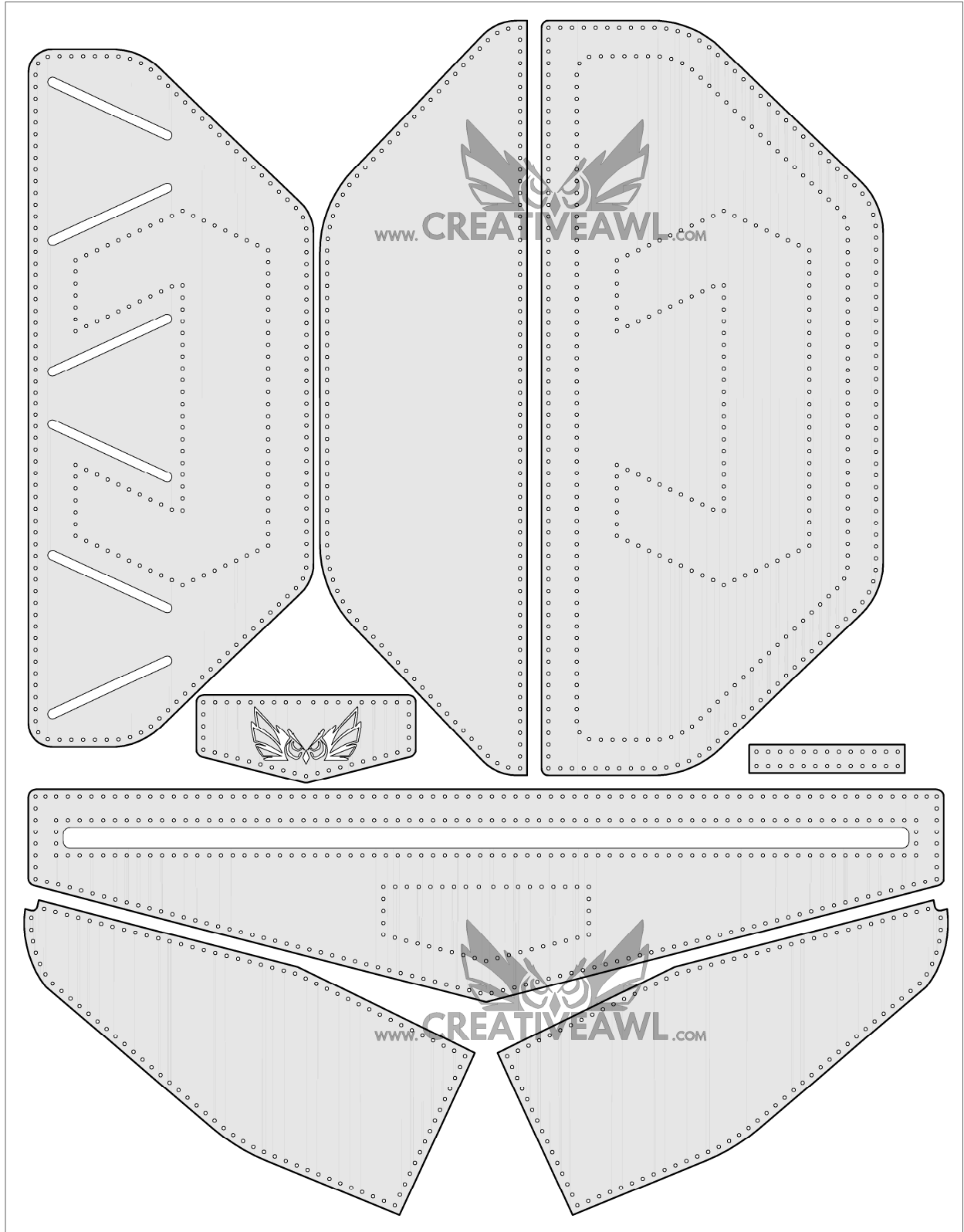
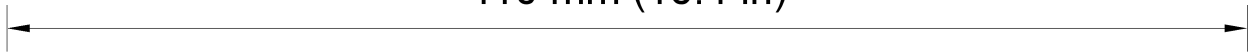

520 mm (20.8 in)



Sketch drawing
Bill of materials



www.CREATIVEAWL.COM

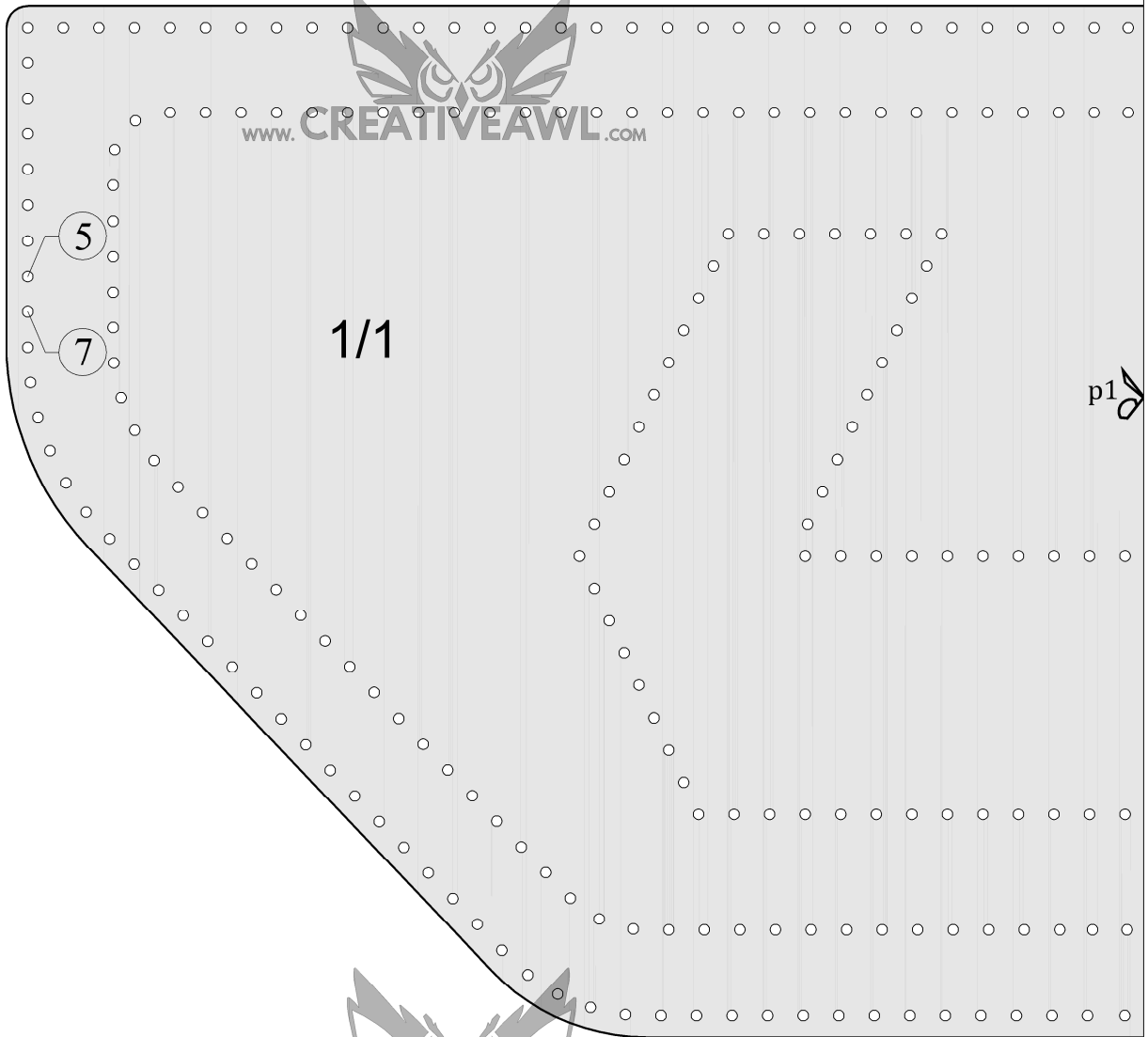

www.CREATIVEAWL.COM

11 in
LETTER
8,5 in

A4

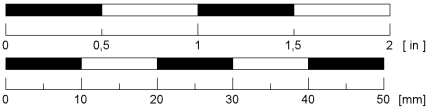

Cross body bag



www.CREATIVEAWL.COM

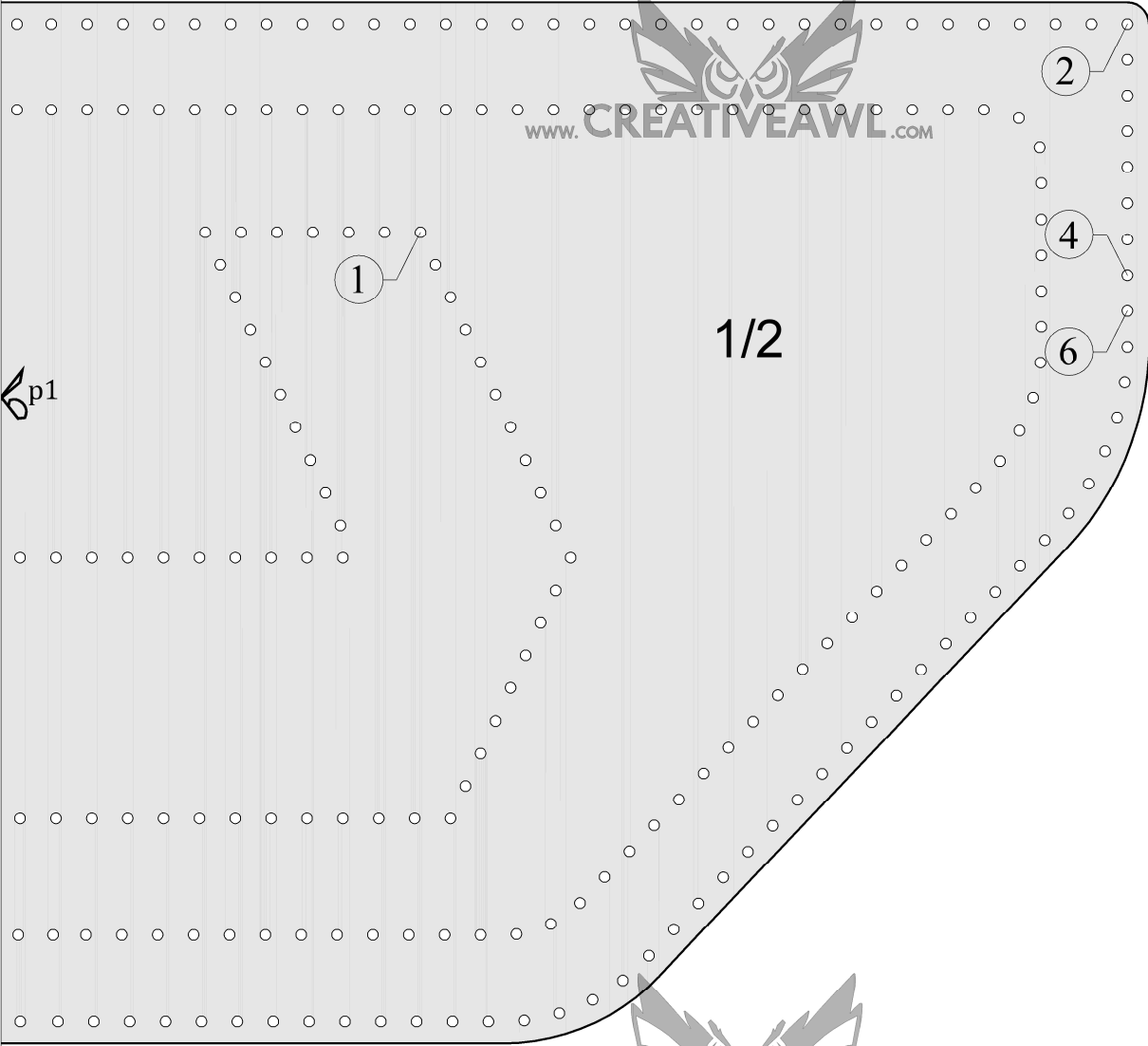

www.CREATIVEAWL.COM

11 in
LETTER
8,5 in

A4

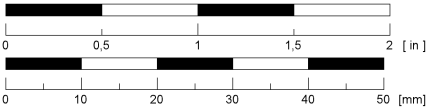

Cross body bag

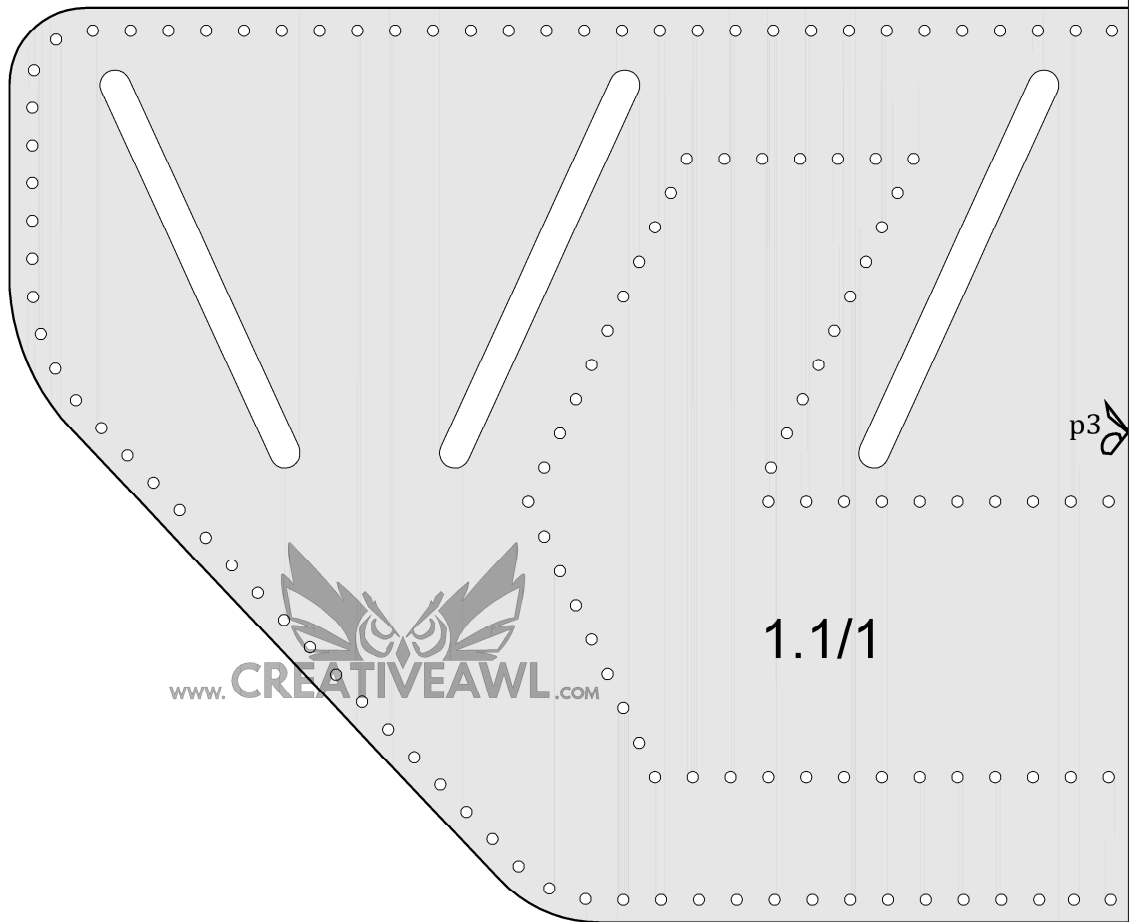
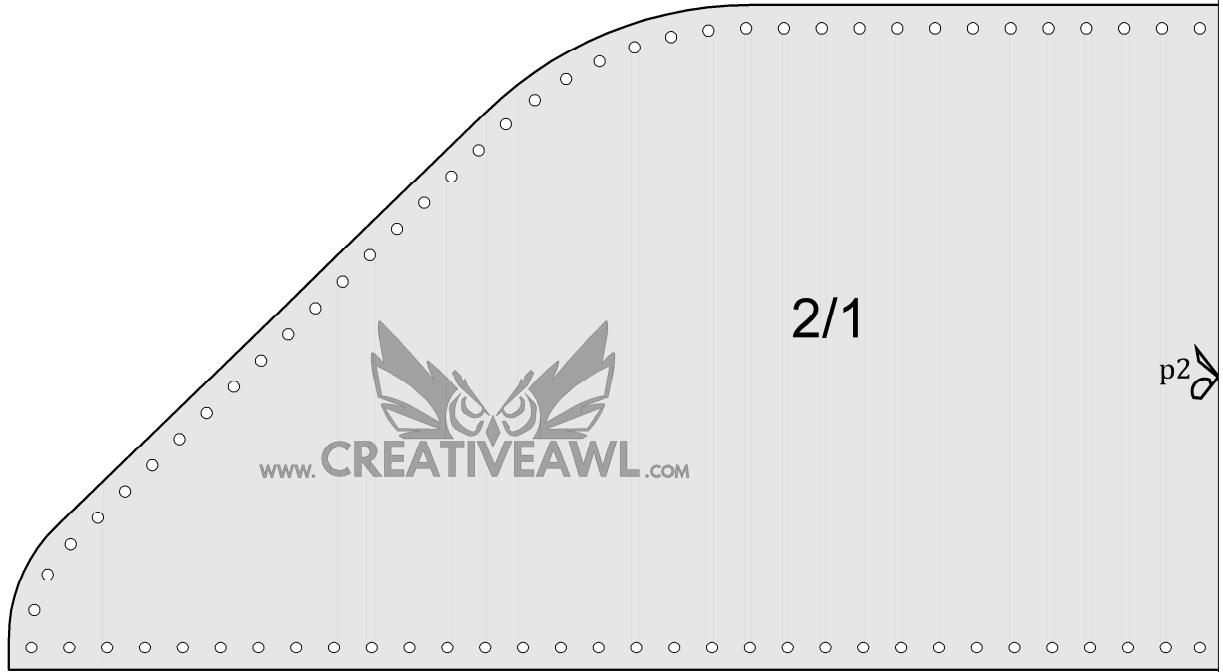

11 in
LETTER
8,5 in

A4

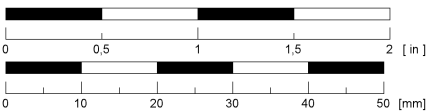

Cross body bag

8

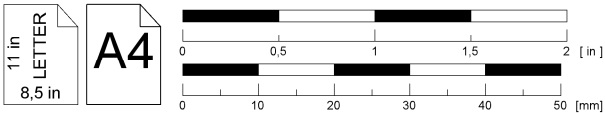
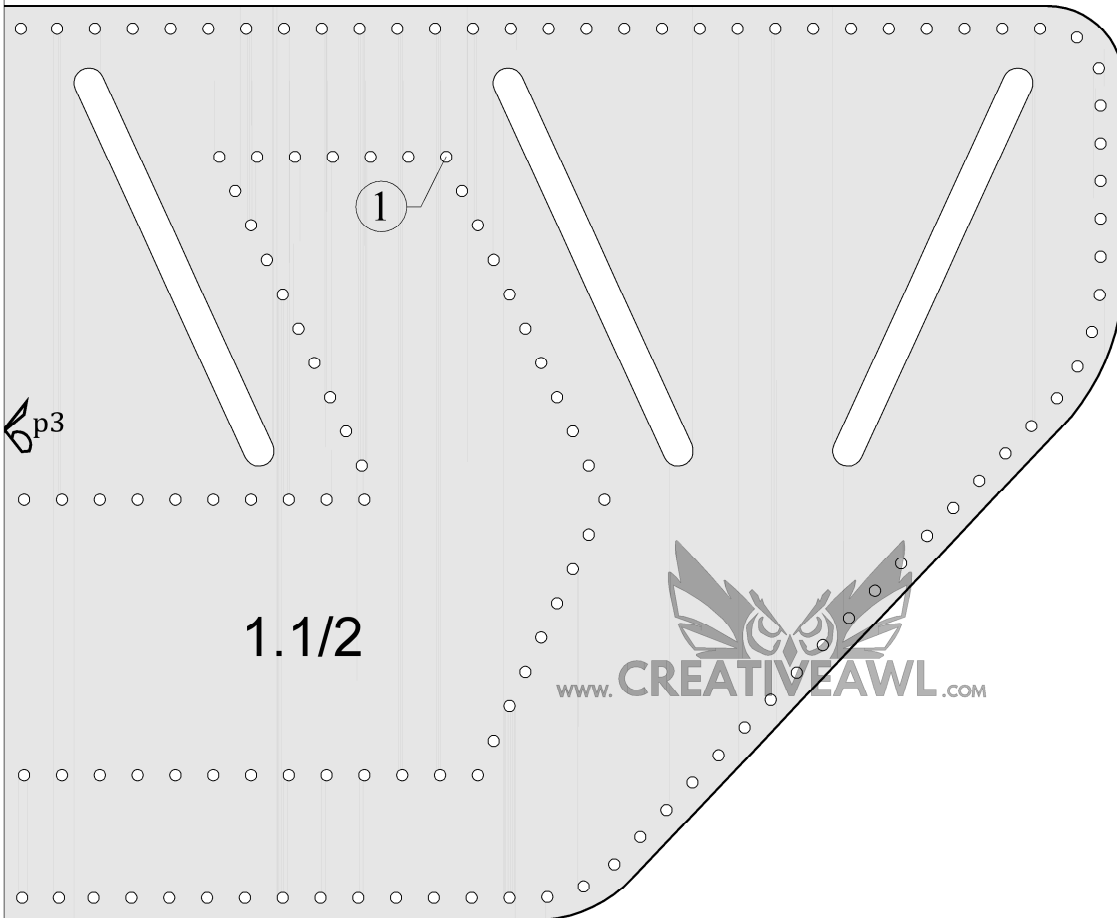
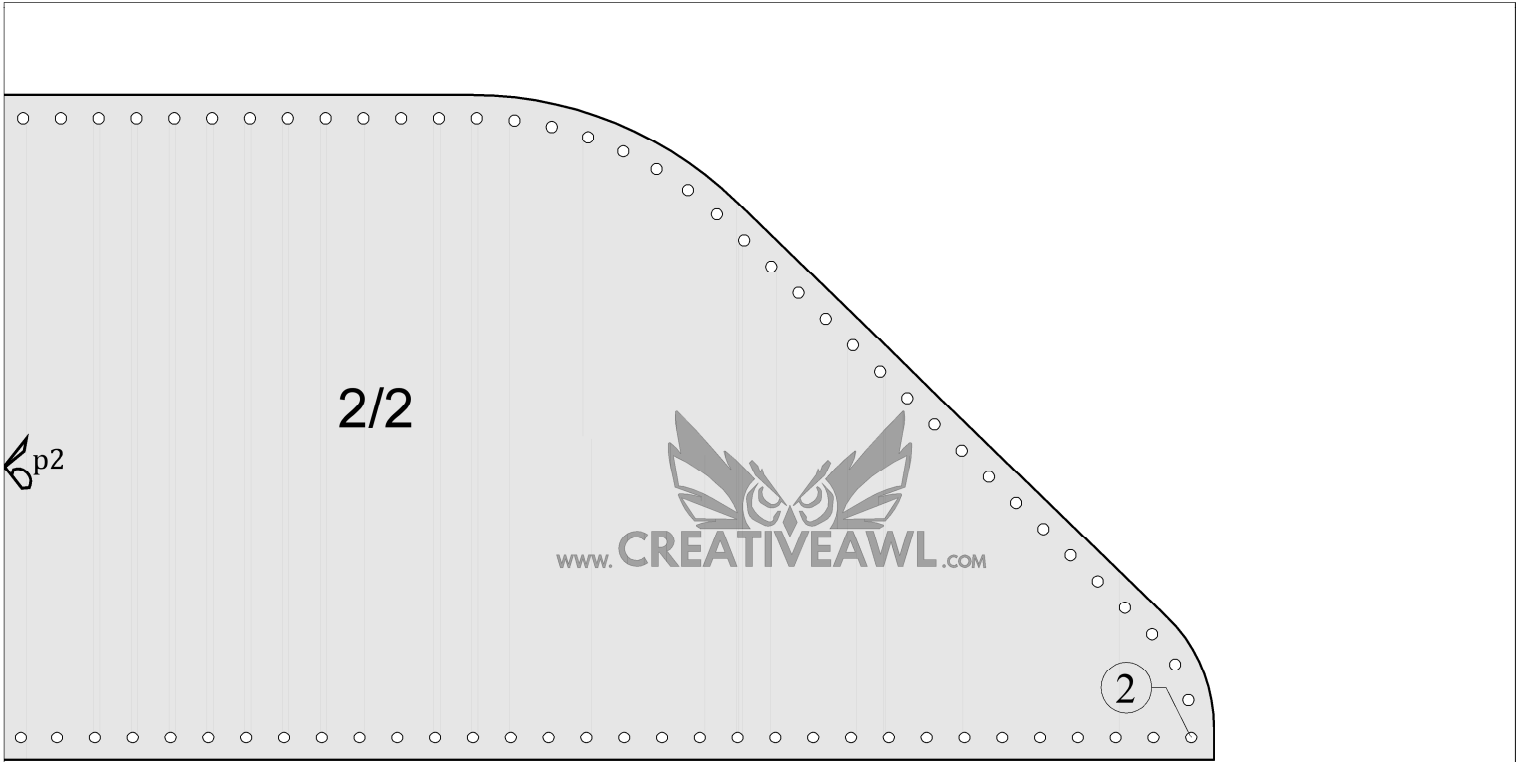

Cross body bag

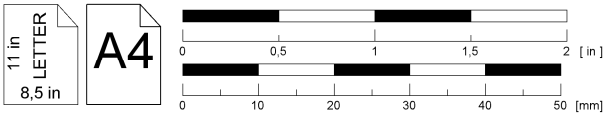
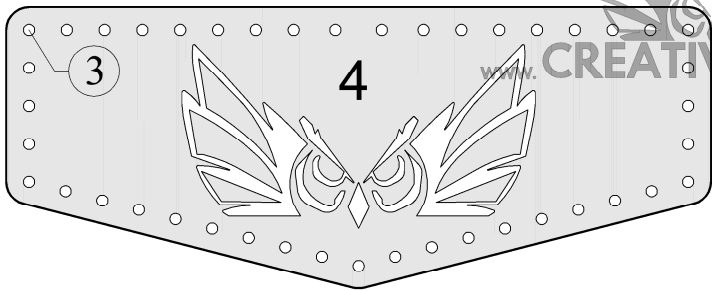
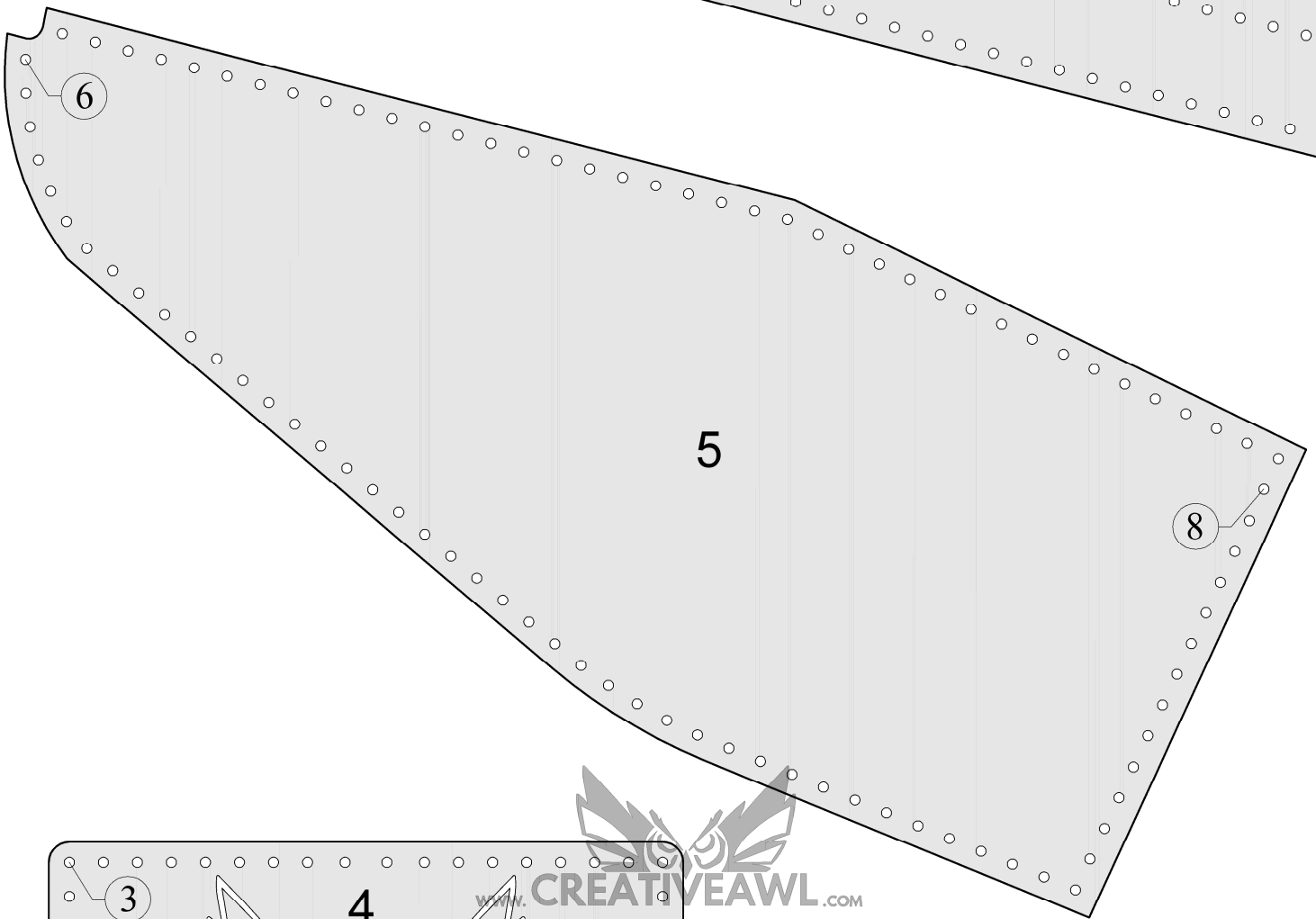
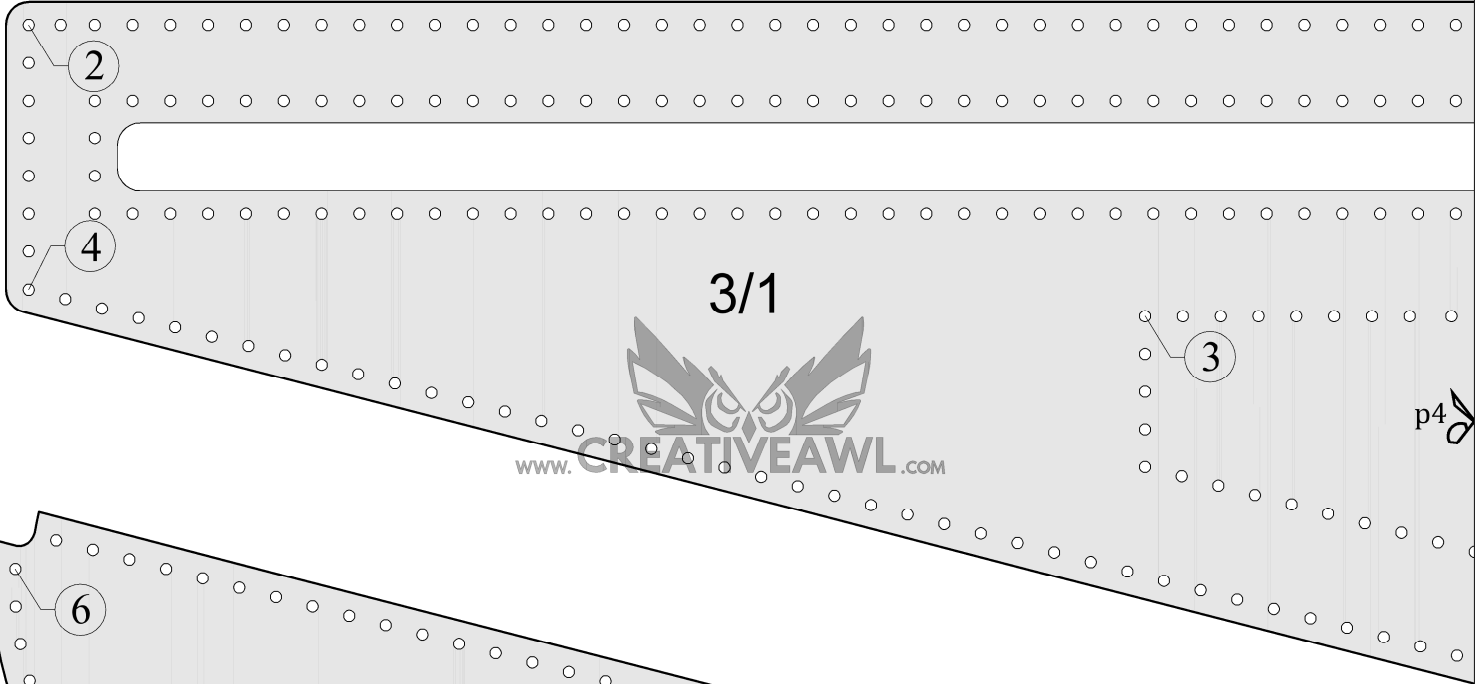

Cross body bag

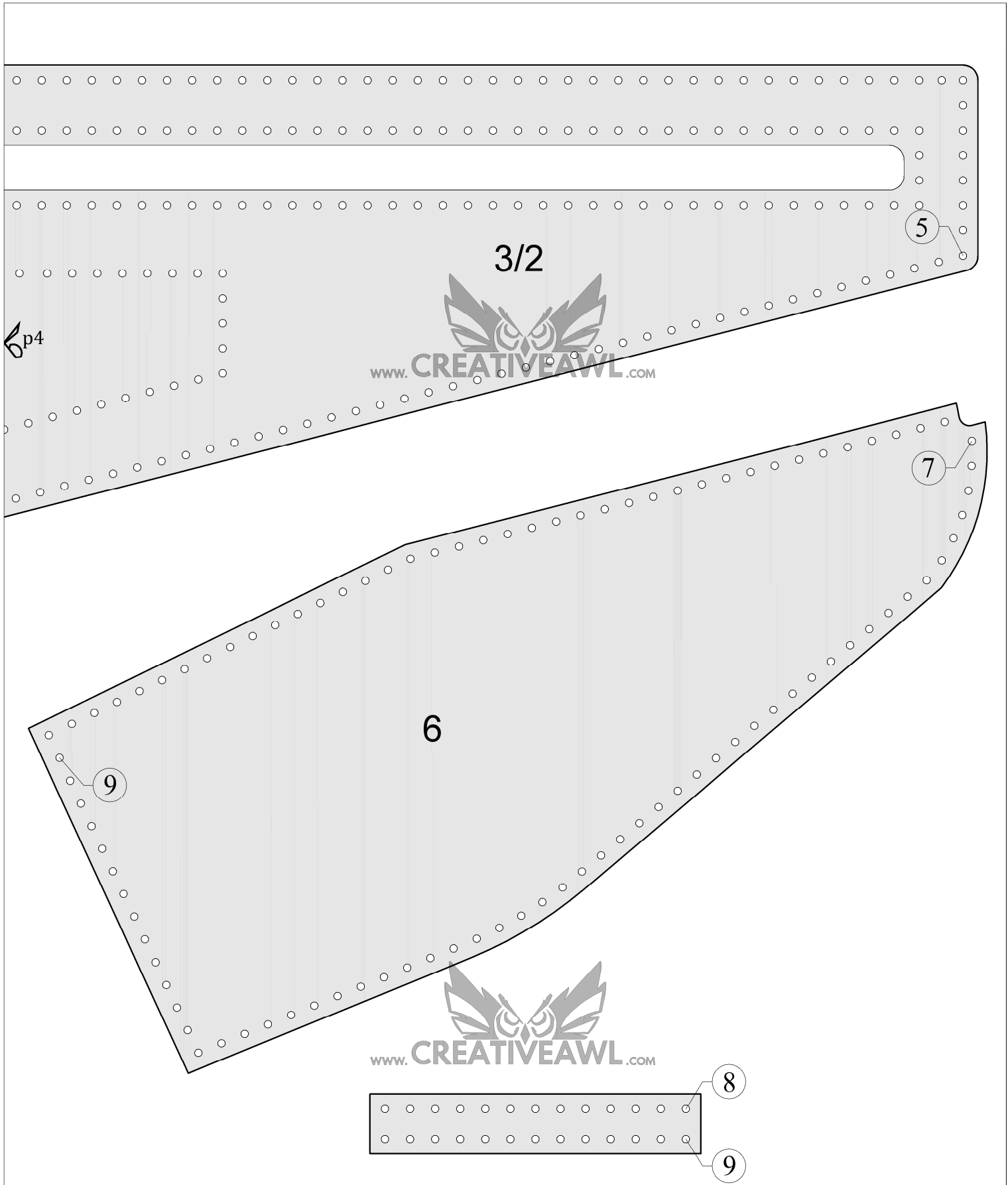

11 in
LETTER
8,5 in

A4

0 0,5 1 1,5 2 [in]

0 10 20 30 40 50 [mm]

Cross body bag

Belt 30 mm

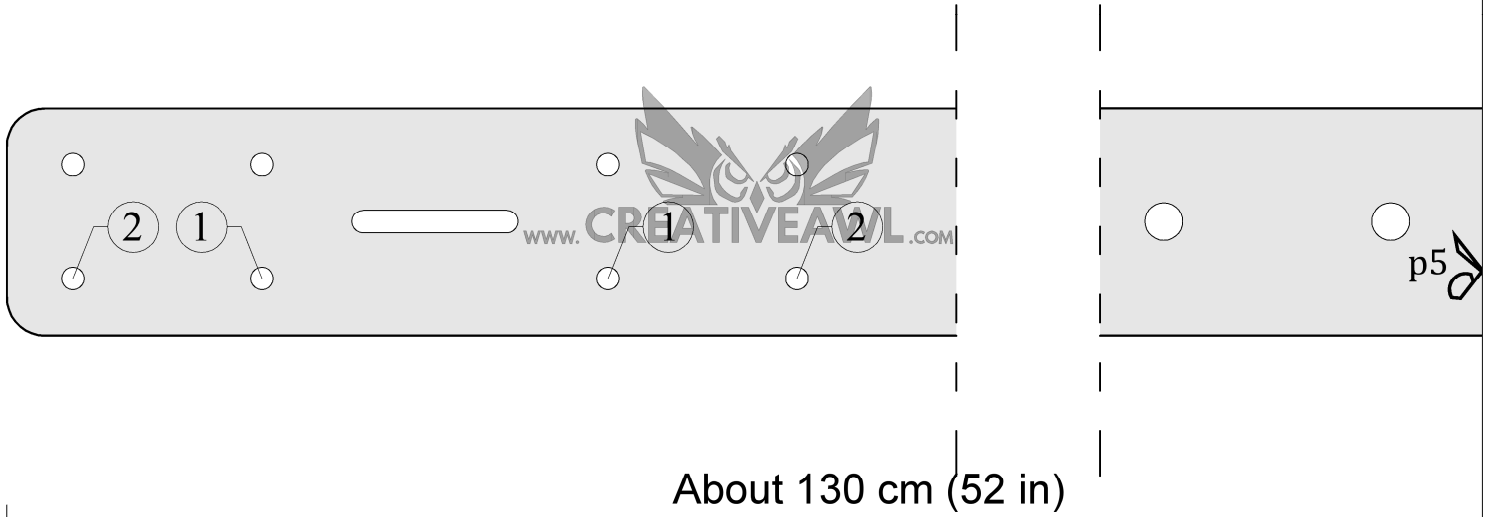

Belt 35 mm

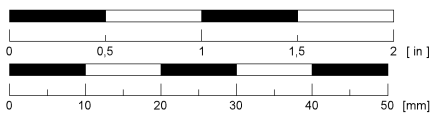
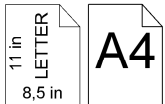
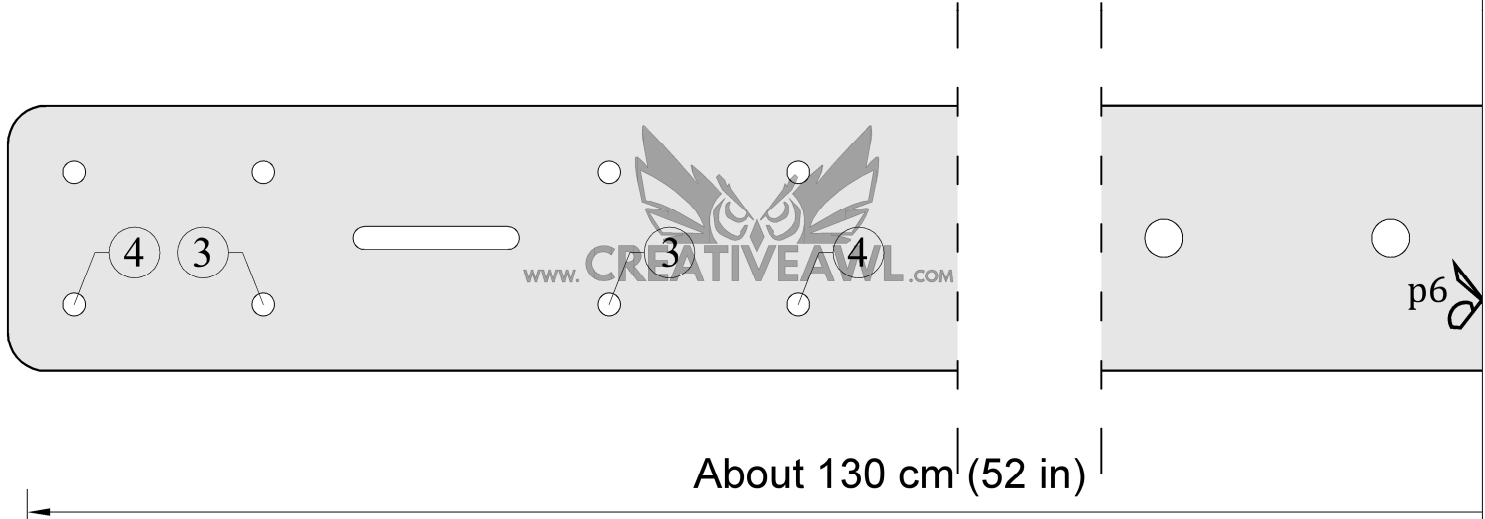

Cross body bag

Belt 30 mm

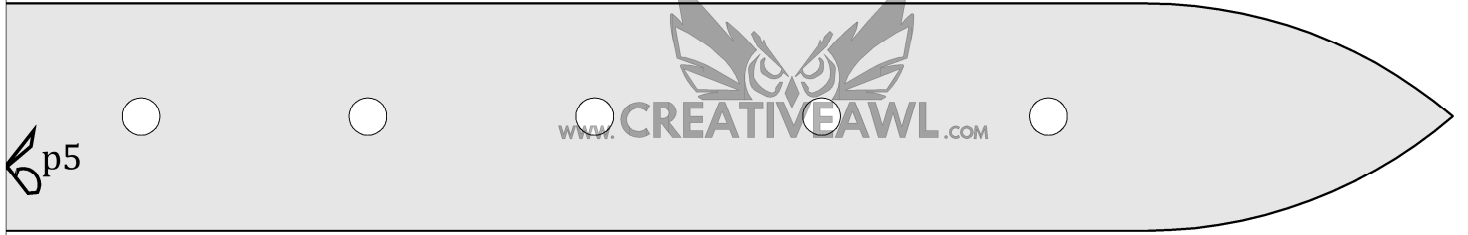

Belt 35 mm



11 in
LETTER
8,5 in

A4

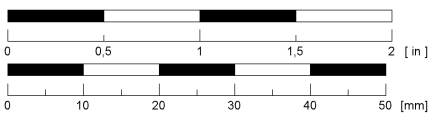

Cross body bag