



#MoodSavannahPattern

“The Savannah Shacket”

Ladies Sizes 00 to 32

Formatted for both
US Letter & A4 Paper

Trimless Option: This is the fastest! No trimming needed! Place left-side margins over right-side margins, overlapping dashed lines and dots. In the same fashion, top margins will overlap bottom margins. Slight unprinted gaps are normal for this method.

Trimmed Option: This removes any unprinted gaps. Trim along the top and right margins at the dashed lines. Overlap the trimmed margins to the untrimmed margins, matching dashed lines and dots.

Tip! Build rows first, then join the rows together as you go.

STOP!

Print only this page first to check accuracy.
The Mood square to the left should measure 2 inches.
Print “actual size” in “portrait” mode (not auto center).
Formatted for both US Letter & A4 paper sizes.

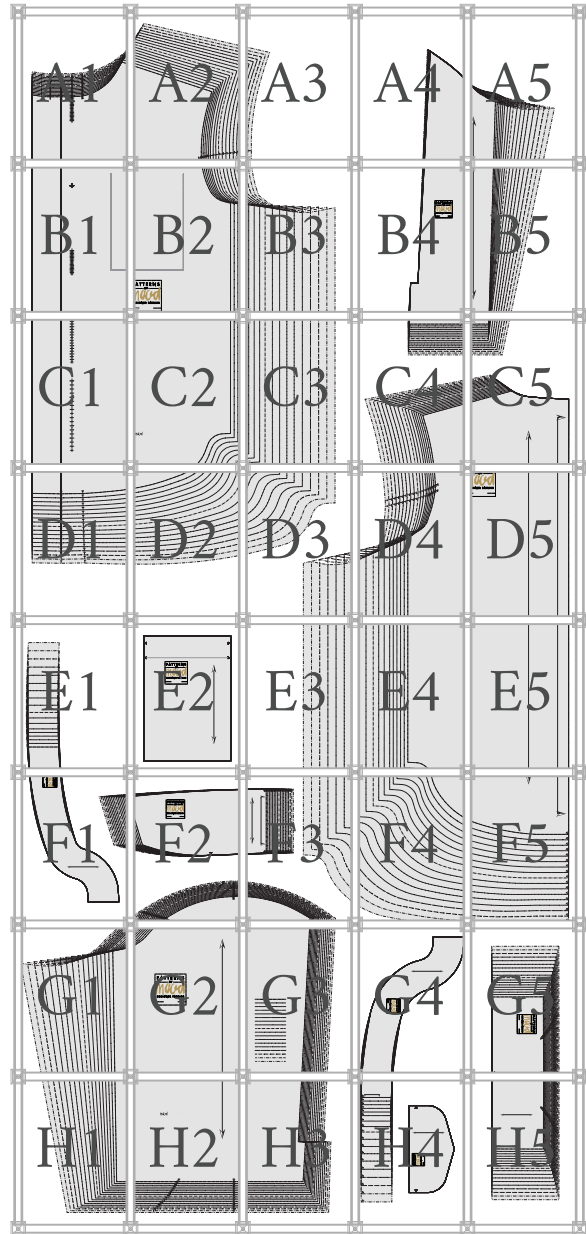

©2021 MoodFabrics.com / MoodSewciety.com
Mass production, resale, or distribution of this
pattern in any form is strictly prohibited.



“The Savannah Shacket”

#MoodSavannahPattern

Ladies Sizes 00 to 32

LADIES SIZE GUIDE

BODY MEASUREMENTS - IN INCHES

DUO-SIZES	00 / 0		2 / 4		6 / 8		10 / 12		14 / 16		18 / 20		22 / 24		26 / 28		30 / 32	
SINGLE SIZES	00	0	2	4	6	8	10	12	14	16	18	20	22	24	26	28	30	32
BUST	31	32	33	34	35	36	37.5	39	40.5	42.5	44.5	46.5	48.5	50.5	52.75	55	57.25	59.5
WAIST	23	24	25	26	27	28	29.5	31	32.5	34.5	36.5	38.5	40.5	42.5	44.75	47	49.25	51.5
HIPS	34	35	36	37	38	39	40.5	42	43.5	45.5	47.5	49.5	51.5	53.5	56	58.5	61	63.5

APPROXIMATE FINISHED GARMENT MEASUREMENTS - IN INCHES

SINGLE SIZES	00	0	2	4	6	8	10	12	14	16	18	20	22	24	26	28	30	32
BUST	41	42	43	44	45	46	47.5	49	50.5	52.5	54.5	56.5	58.5	60.5	62.75	65	67.25	69.5
WAIST	41	42	43	44	45	46.5	47.5	49	50.5	52.5	54.5	56.5	58.5	60.5	62.75	65	67.25	69.5
SLEEVE LENGTH*	32.52	32.18	31.8	31.5	31.8	32.18	32.59	33	33.41	33.88	34.35	34.82	35.29	35.76	36.23	36.7	37.17	37.64
SHIRT LENGTH**	28.88	29.25	29.6	30	34.3	34.63	35	35.39	35.78	36.16	36.55	36.94	37.33	37.71	38.1	38.49	38.88	39.26

* Measured from center back neck to bottom of sleeve cuff. ** Measured from top of shoulder to bottom of front hem.

Fitting notes: Drafted for woven or stable knit fabrics such as fleece and flannel. The fit is intentionally oversized, with about ten inches of ease through the bust and waist - this amounts to about a 2.5-inch extra "pinch" on each side of the body. Choose size according to desired finished garment measurements. As a best practice, sew a test garment to adjust the pattern as needed.

We love creating these free patterns for the community and we want to keep them free! In return, we hope you check out MoodFabrics.com for your next project!

Want to use one of our patterns to make a garment to sell? Our patterns are royalty-free! We just ask that you credit us with MoodSewciety.com or MoodFabrics.com in your product description.

♥ The Mood Sewciety Team

mood SEWCİETY

FOR SEWING INSTRUCTIONS:

Scan the QR code or visit
MoodSewciety.com and search
"MDF280"



1/2" seam allowances (SA's) included
unless stated otherwise.

©2021 MoodFabrics.com / MoodSewciety.com
Mass production, resale, or distribution of this
pattern in any form is strictly prohibited.

mood SEWCİETY

IN COLLABORATION WITH PaTternHack.COM



MDF280

“The Savannah Shacket”

#MoodSavannahPattern

Ladies Sizes 00 to 32

A	A - COLLAR FABRIC: CUT 2 FUSING: CUT 1 OR 2 ON FOLD
B	B - FRONT FABRIC: CUT 2 FUSING: CUT 2 (PLACKET AREA) MIRRORED PAIRS
C	C - FRONT HEM FACING FABRIC OR CONTRAST: CUT 2 MIRRORED PAIR
D	D - POCKET FABRIC: CUT 2
E	E - POCKET FLAP FABRIC: CUT 4
F	F - SLEEVE FABRIC: CUT 2 MIRRORED PAIR
G	G - BACK SLEEVE FABRIC: CUT 2 MIRRORED PAIR
H	H - CUFF FABRIC: CUT 4 FUSING: CUT 2 OR 4 MIRRORED PAIRS
I	I - BACK FABRIC: CUT 1 ON FOLD
J	J - BACK HEM FACING FABRIC OR CONTRAST: CUT 1 ON FOLD

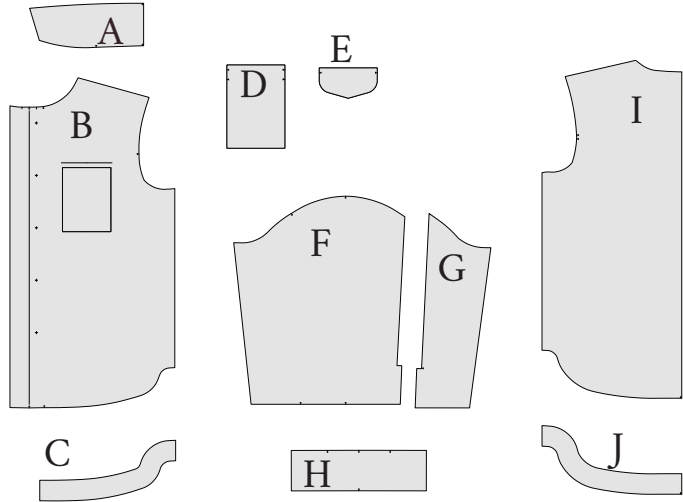

Size Line Key

SIZE 00	-----
SIZE 0	=====
SIZE 2	=====
SIZE 4	=====
SIZE 6	=====
SIZE 8	=====
SIZE 10	=====
SIZE 12	=====
SIZE 14	=====
SIZE 16	=====
SIZE 18	=====
SIZE 20	=====
SIZE 22	=====
SIZE 24	=====
SIZE 26	=====
SIZE 28	=====
SIZE 30	=====
SIZE 32	=====

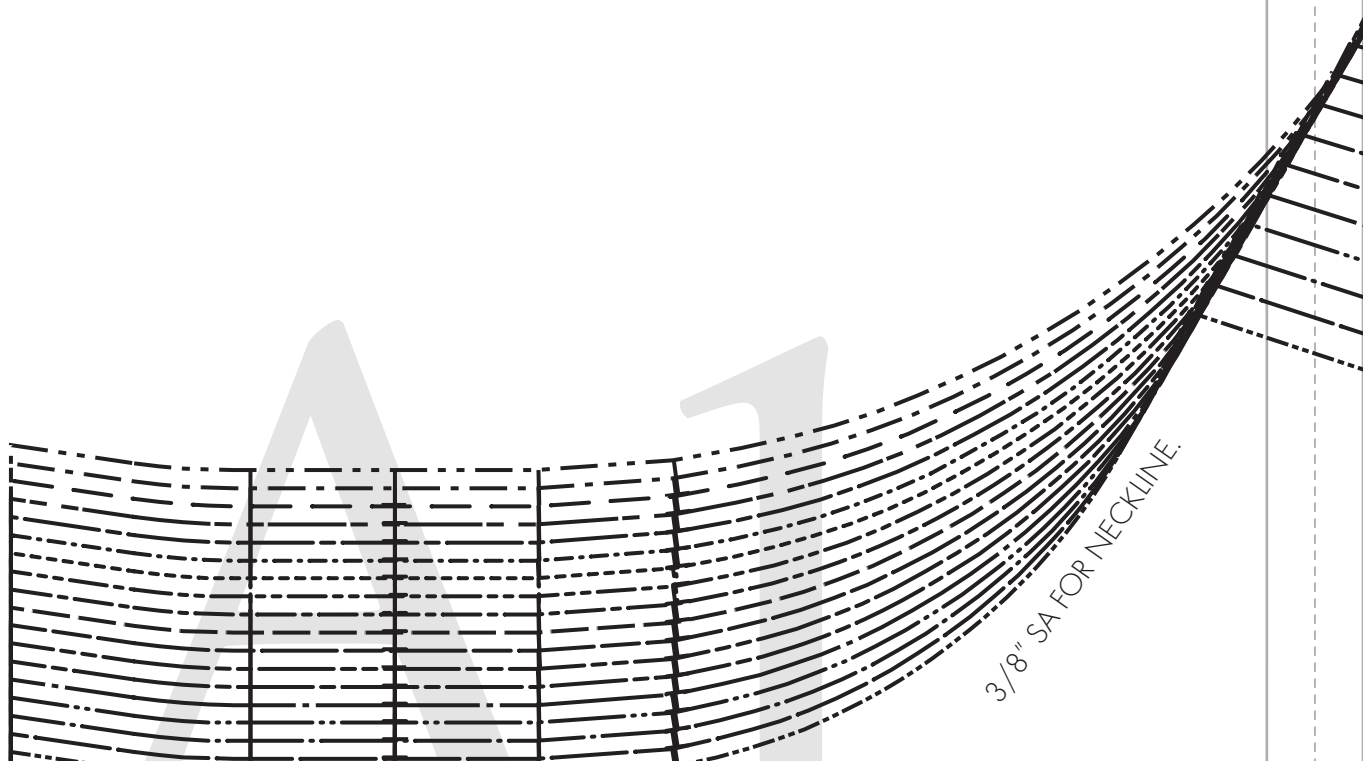

3/8" SA FOR NECKLINE.

32
28
24
20
18
16
12
10
8
6
4
2
00

+ MARKINGS
INDICATE BUTTON
PLACEMENT AND
CENTER OF VERTICAL
BUTTONHOLES

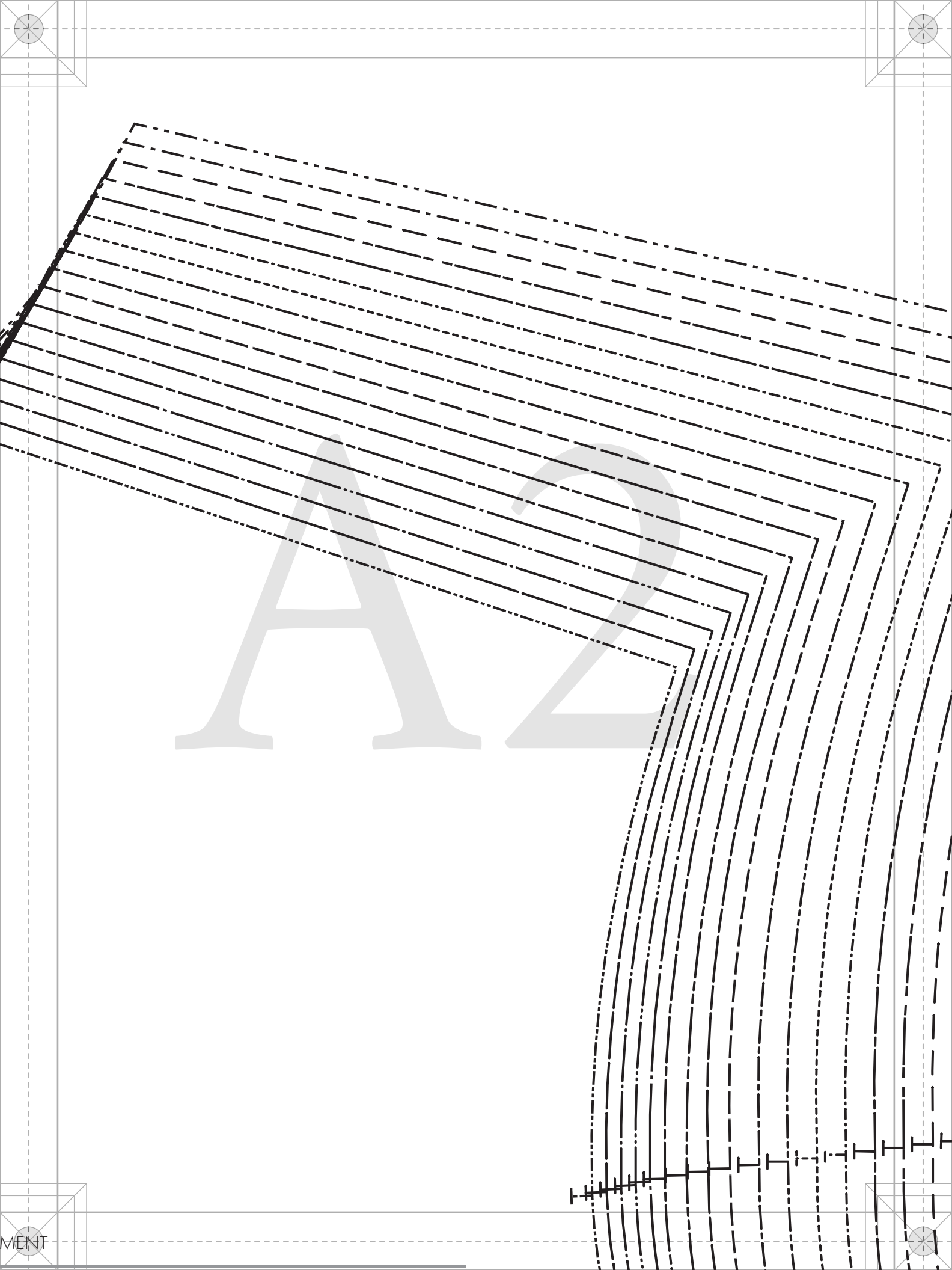

AZ

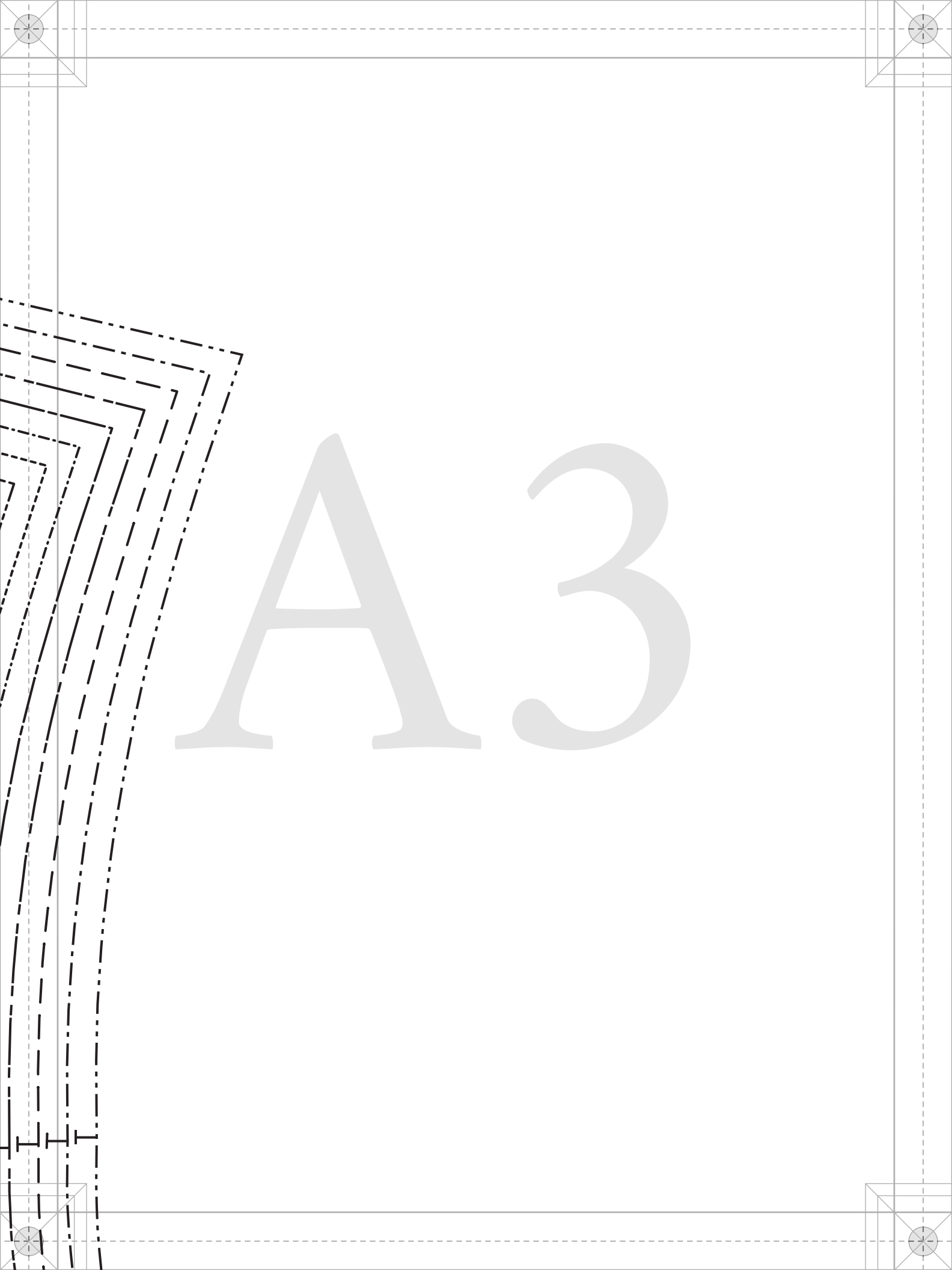

A4

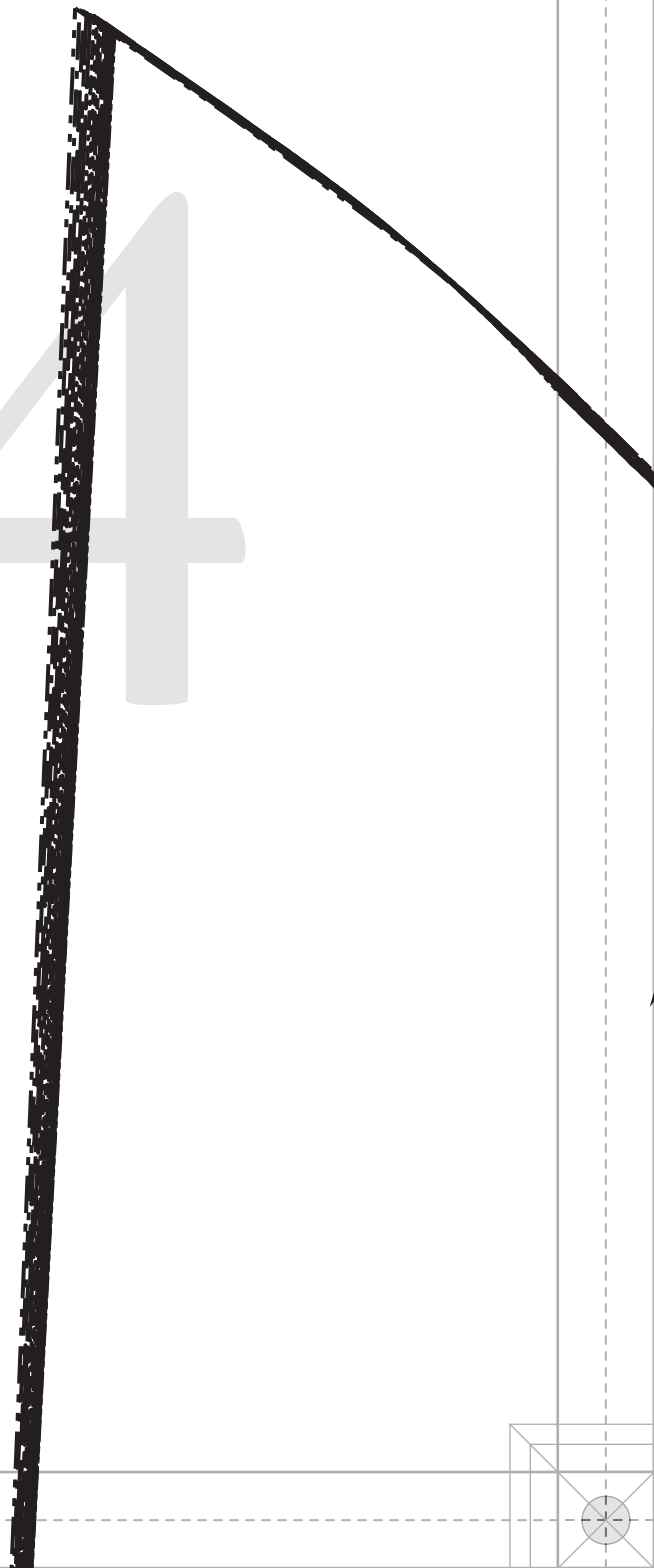

A5

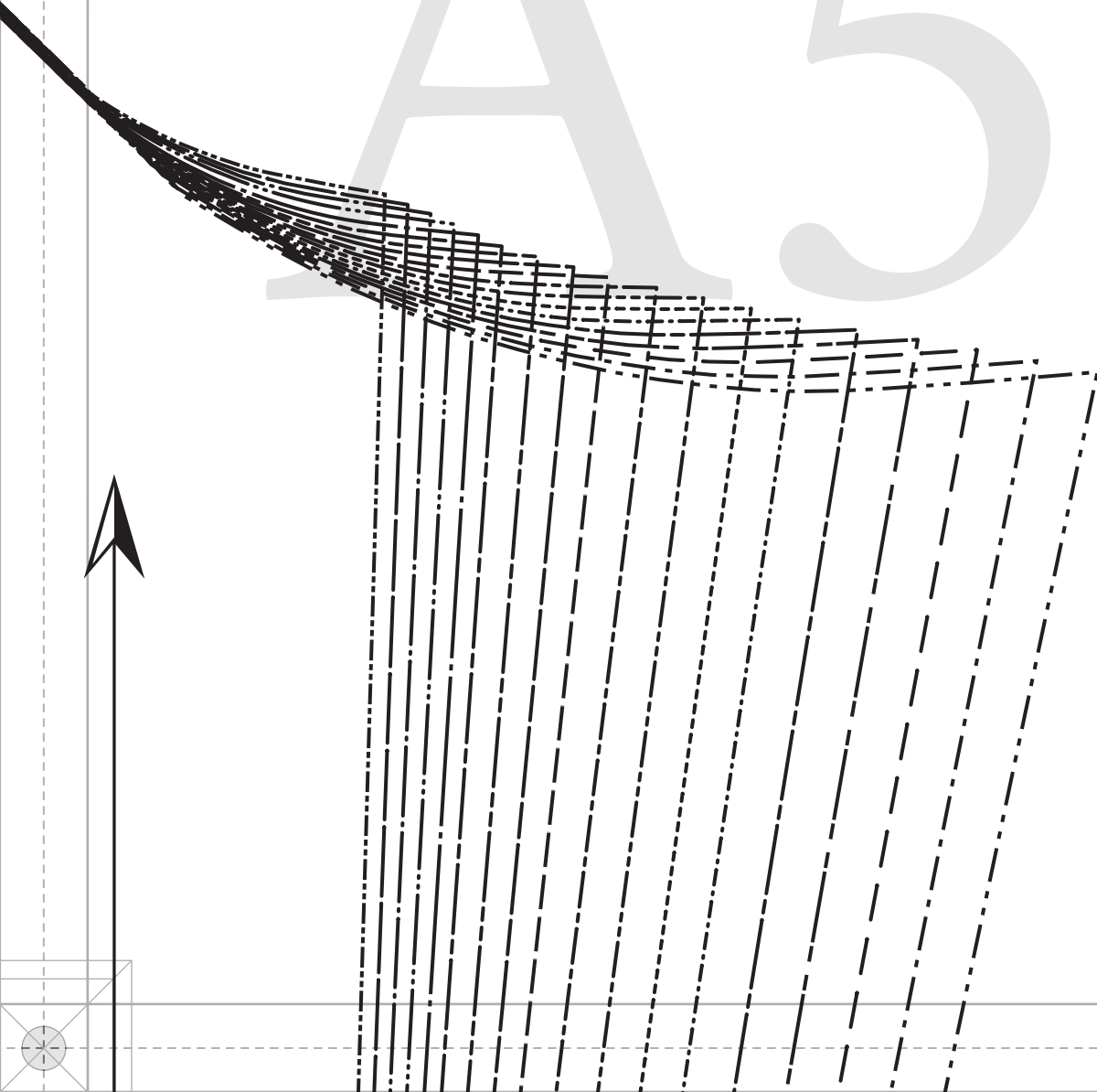

FLAP PLACEMENT

POCKET PLACEMENT

+

B 1

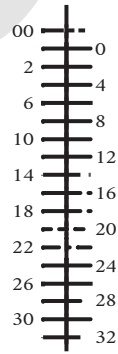

P
D

00
0

MENT

CEMENT

B2

PATTERNS
BY
maood
DESIGNER FABRICS

MDF280

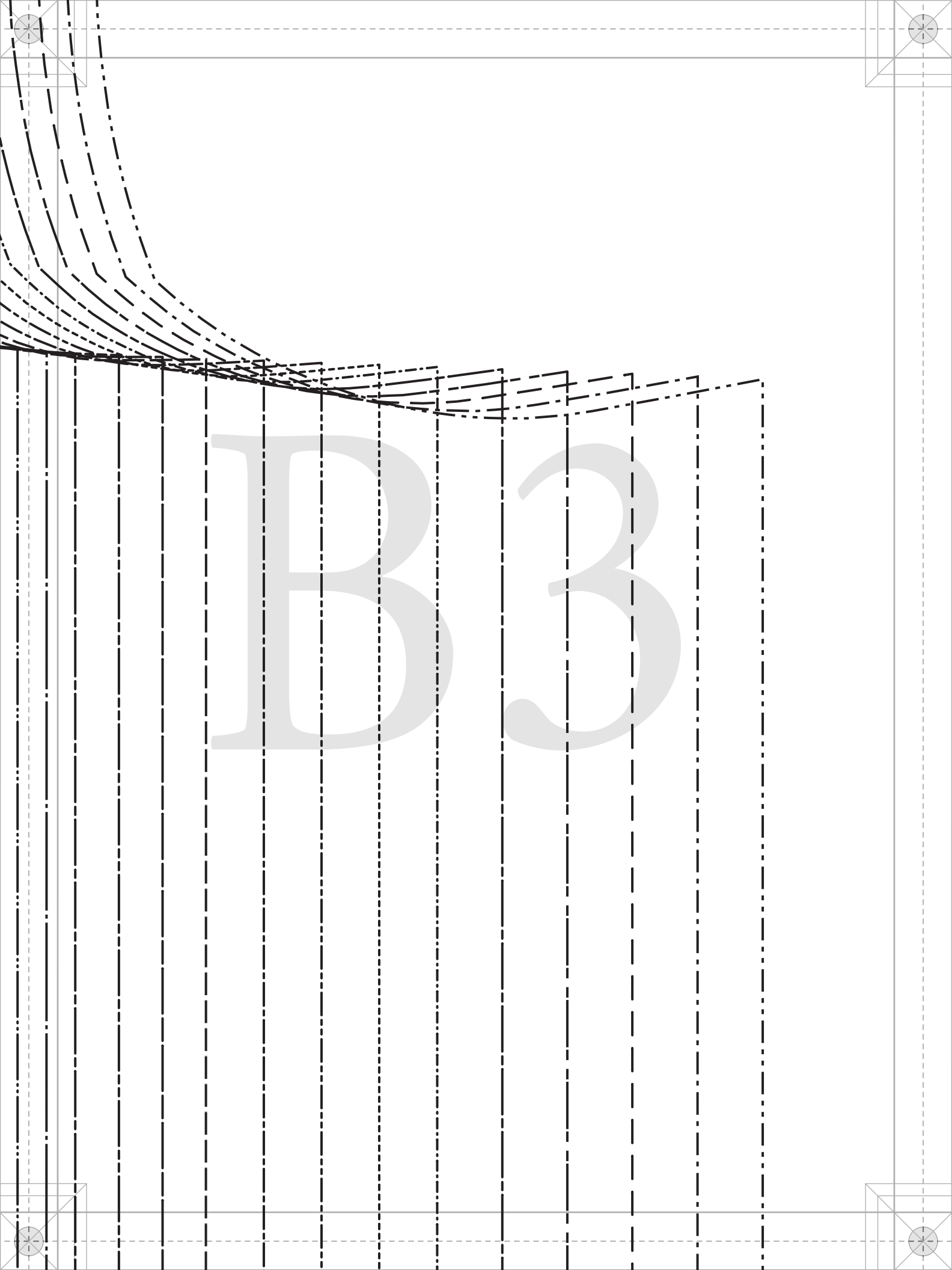



#MoodSavannahPattern

**“The Savannah Shacket”
MDF280**

**G - BACK SLEEVE
FABRIC: CUT 2
MIRRORED PAIR**

LADIES SIZES 00 TO 32
1/2" seam allowances (SA's)
included unless stated otherwise.

DOUBLE-TURN HEM FOR SLIT

GRAINLINE

35



#Mood

“The Sav

B
FA

FUSING: CU
MIRI

1/
incl

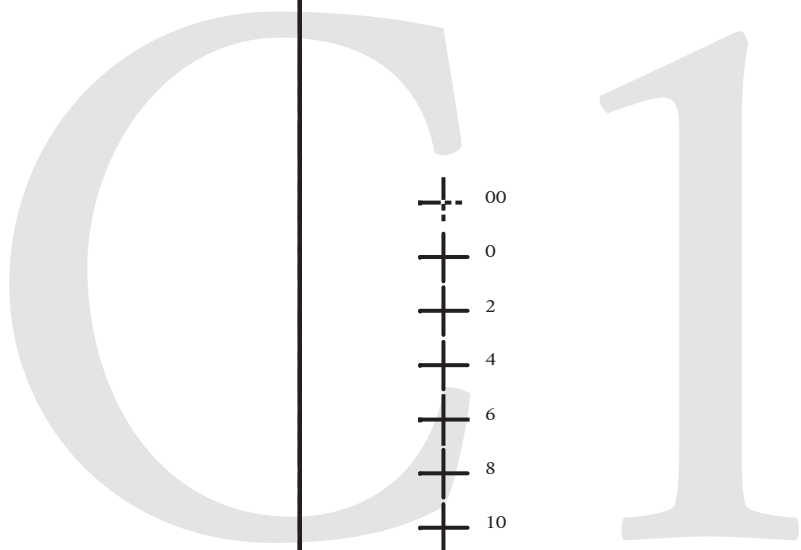
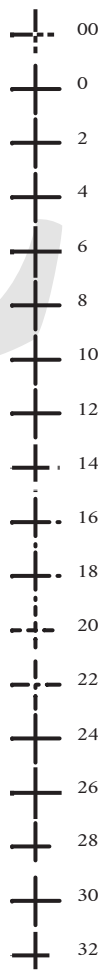
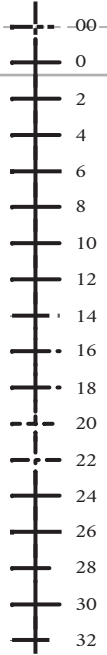

oodSavannahPattern

Savannah Shacket”

MDF280

B - FRONT
FABRIC: CUT 2
CUT 2 (PLACKET AREA)
MIRRORED PAIRS

C 2

LADIES SIZES 00 TO 32
1/2" seam allowances (SA's)
included unless stated otherwise.

mood SEWCiETY
IN COLLABORATION WITH
PaTternHack.com

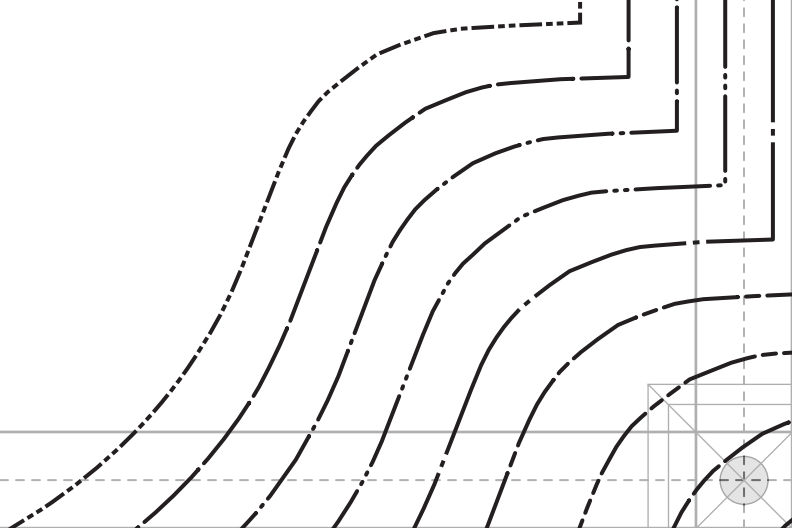

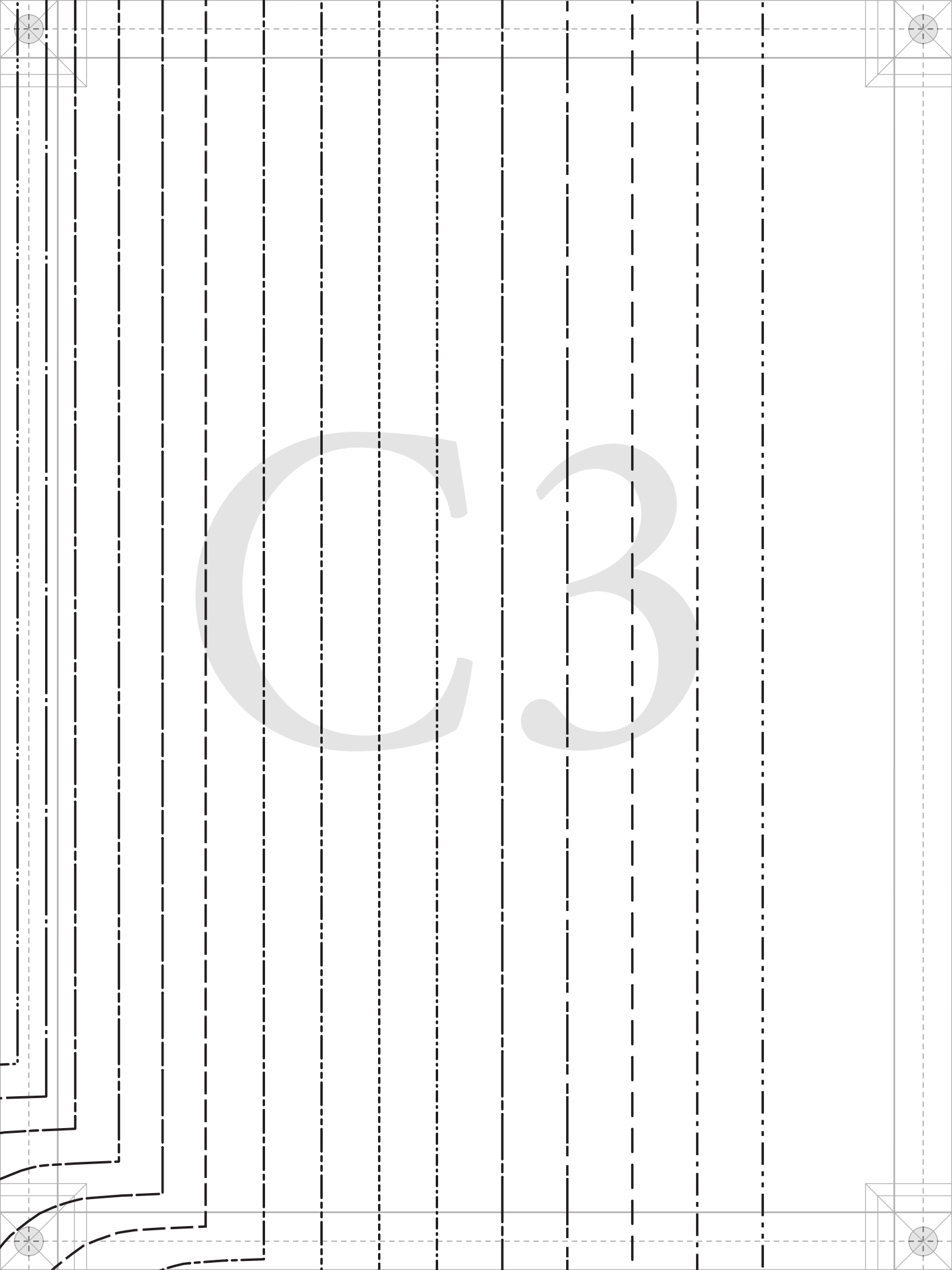

C 3

OR SLIT

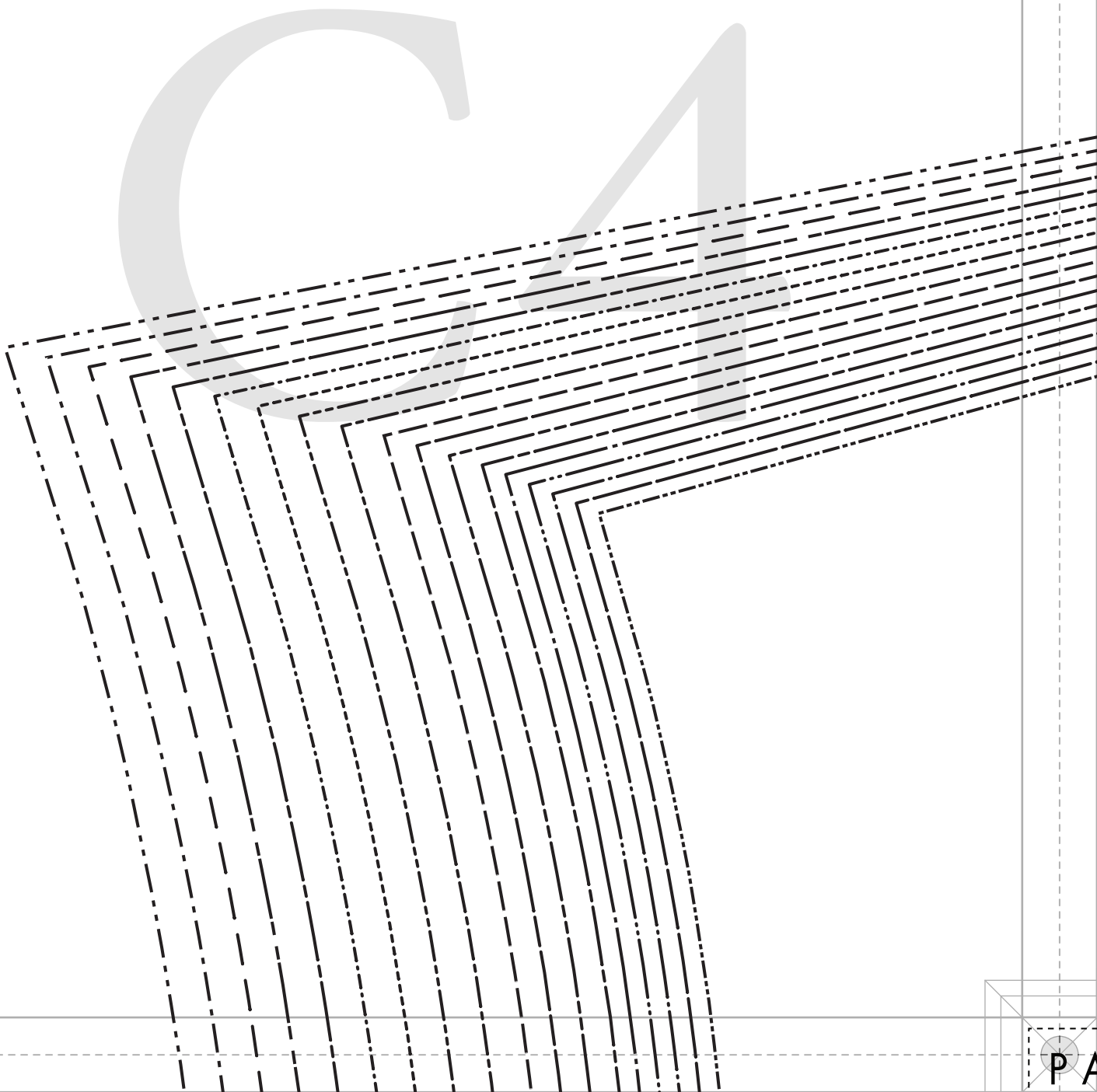

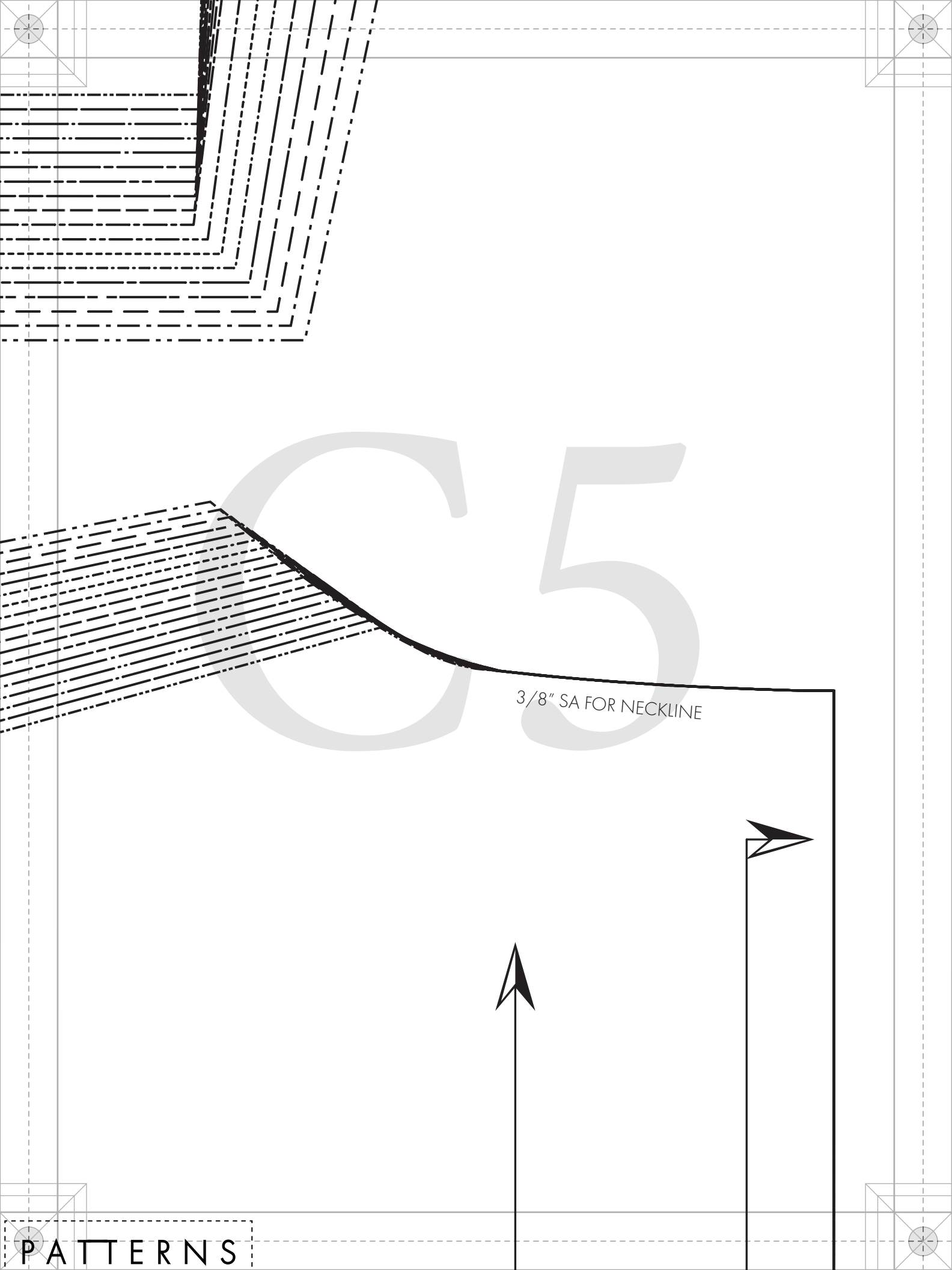

3/8" SA FOR NECKLINE

3/8" SA FOR SEAMED HEM WITH FA

DI

WITH FACING

12

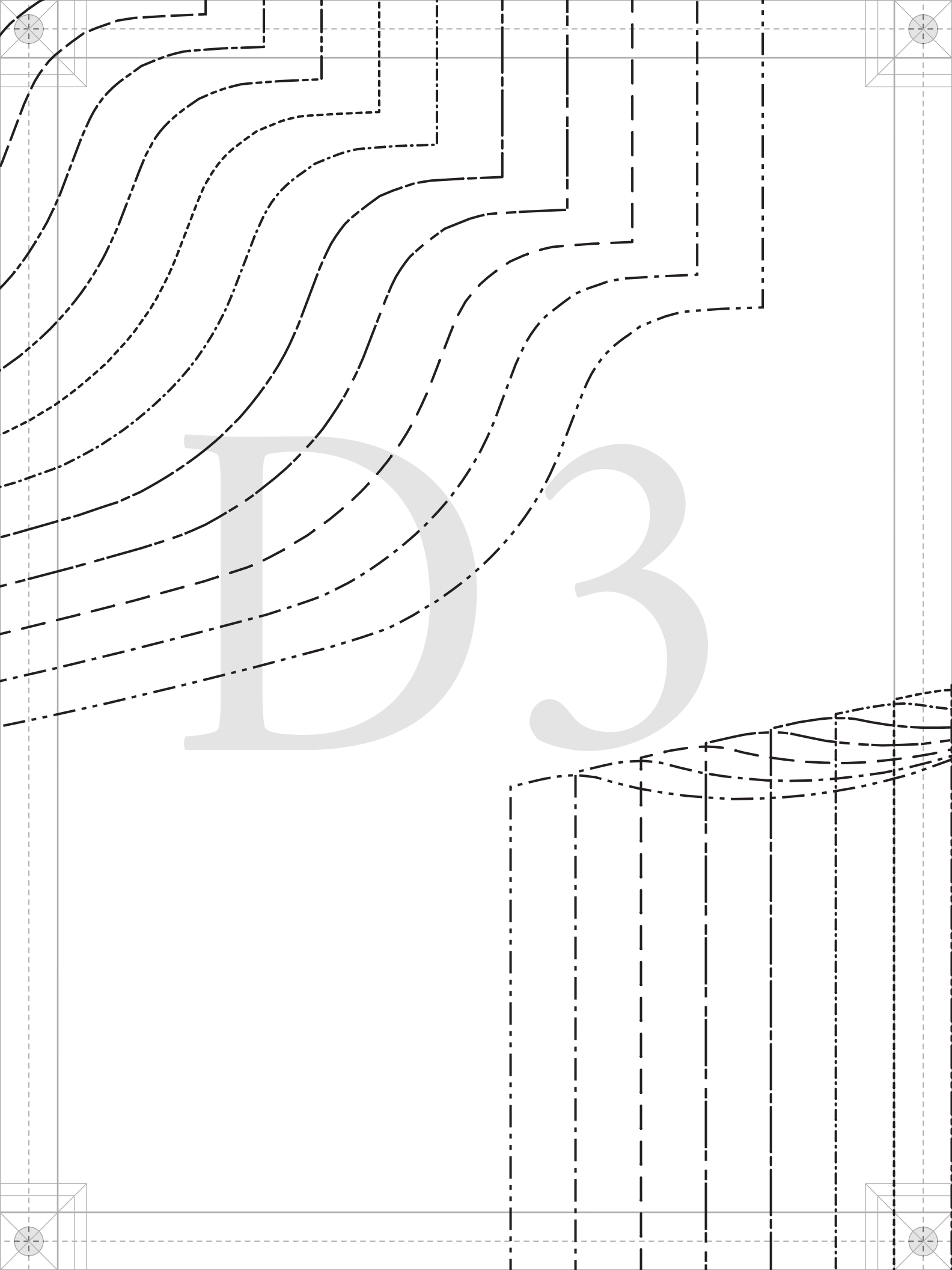

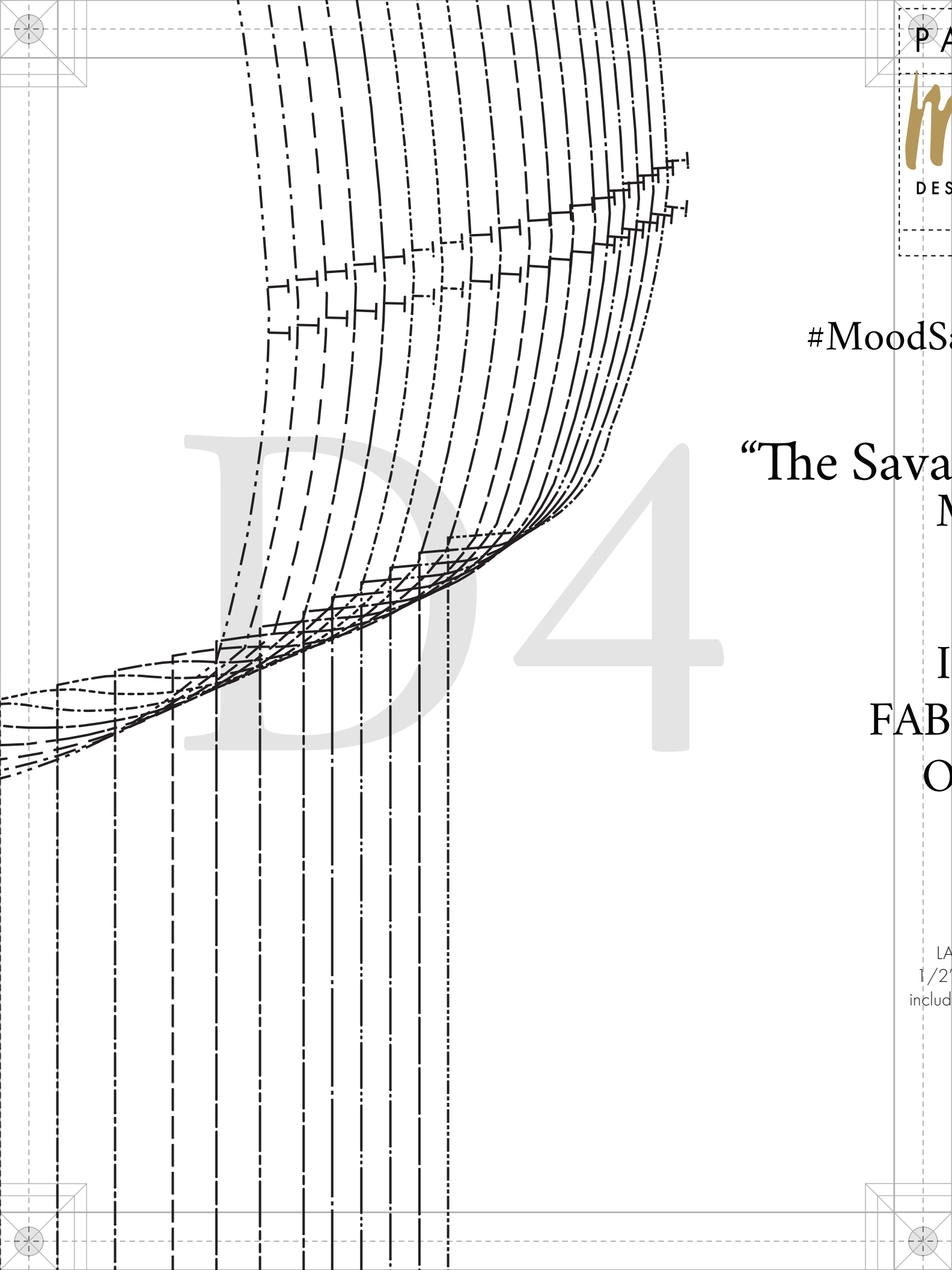

P A

m

DES

#MoodS

“The Sava

M

I

FAB

O

LA
1/2
includ

PATTERNS

BY

mood

DESIGNER FABRICS

MDF280

oodSavannahPattern

Savannah Shacket"

MDF280

I - BACK

FABRIC: CUT 1

ON FOLD

LADIES SIZES 00 TO 32

1/2" seam allowances (SA's)

included unless stated otherwise.

GRAINLINE

ON FOLD OF FABRIC

SIZE 32

SIZE 30

SIZE 28

SIZE 26

SIZE 24

SIZE 22

SIZE 20

SIZE 18

SIZE 16

SIZE 14

SIZE 12

SIZE 10

SIZE 8

SIZE 6

SIZE 4

SIZE 2

SIZE 0

SIZE 00

EE1

“The Savz

DE M P

PATTERNS

BY

mood

DESIGNER FABRICS

MDF280

#MoodSavannahPattern

“The Savannah Shacket”
MDF280

D - POCKET
FABRIC: CUT 2

LADIES SIZES 00 TO 32
1/2" seam allowances (SA's)
included unless stated otherwise.

TOP EDGE OF POCKET

GRAINLINE

E 3

E 4

E5

PLACE ON F

E

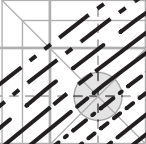
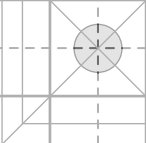

PATTERNS
 BY
Mood
 DESIGNER FABRICS
 MDF280

Savannah Shacket™
 MDF280

1/4" SA FOR UPPER EDGE (SERGE OR TURN UNDER)

C - FRONT HEM FACING
 FABRIC OR CONTRAST; CUT 2
 MIRRORED PAIR

3/8" SA FOR LOWER EDGE

GRAINLINE

1/2" SA AT SIDE SEAM

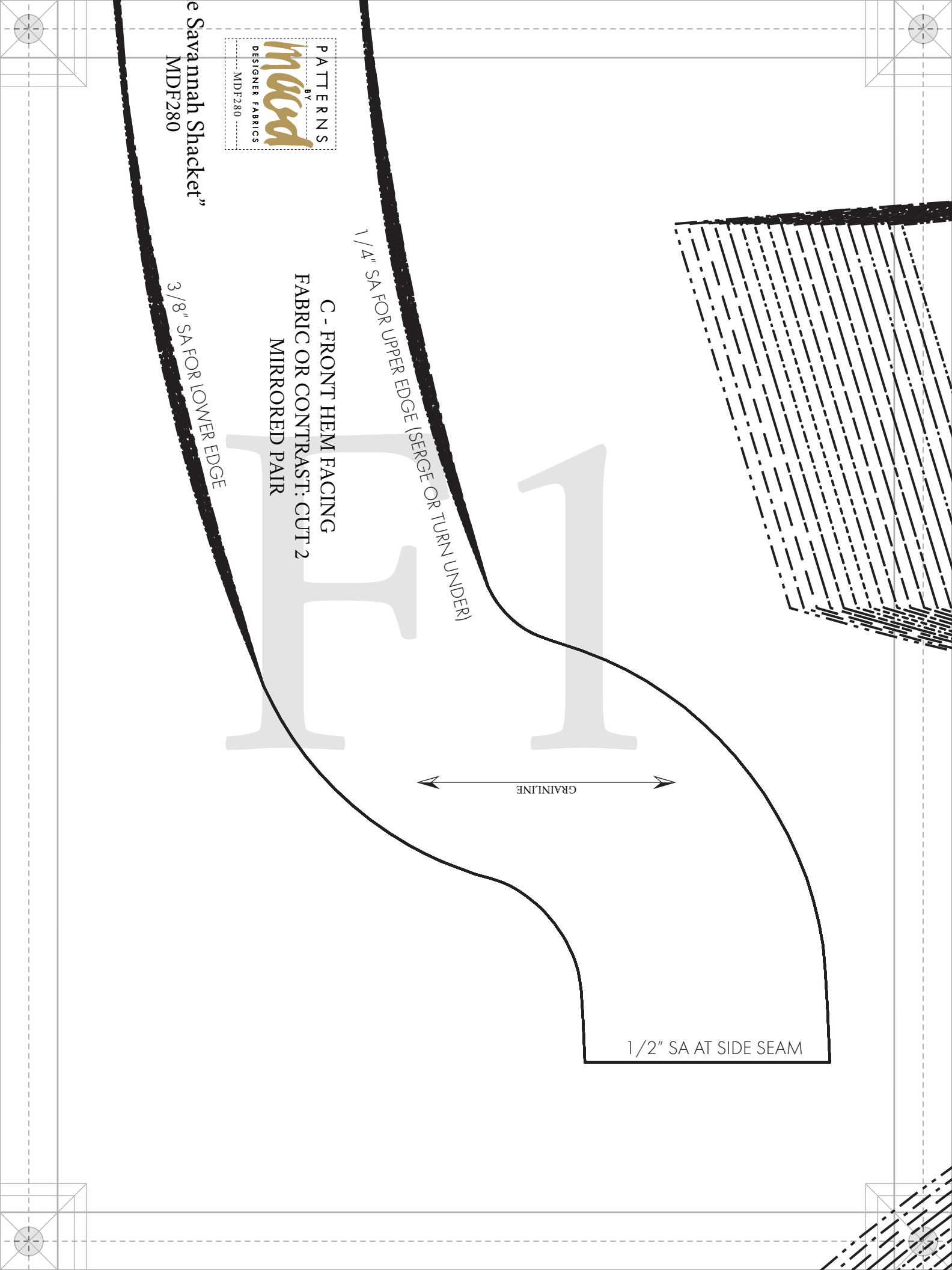



A - COLLAR
FABRIC: CUT 2
FUSING: CUT 1 OR 2
ON FOLD

#MoodSavannahPattern

“The Savannah Shacket”
MDF280

LADIES SIZES 00 TO 32
3/8" seam allowances (SA's)
for this piece.

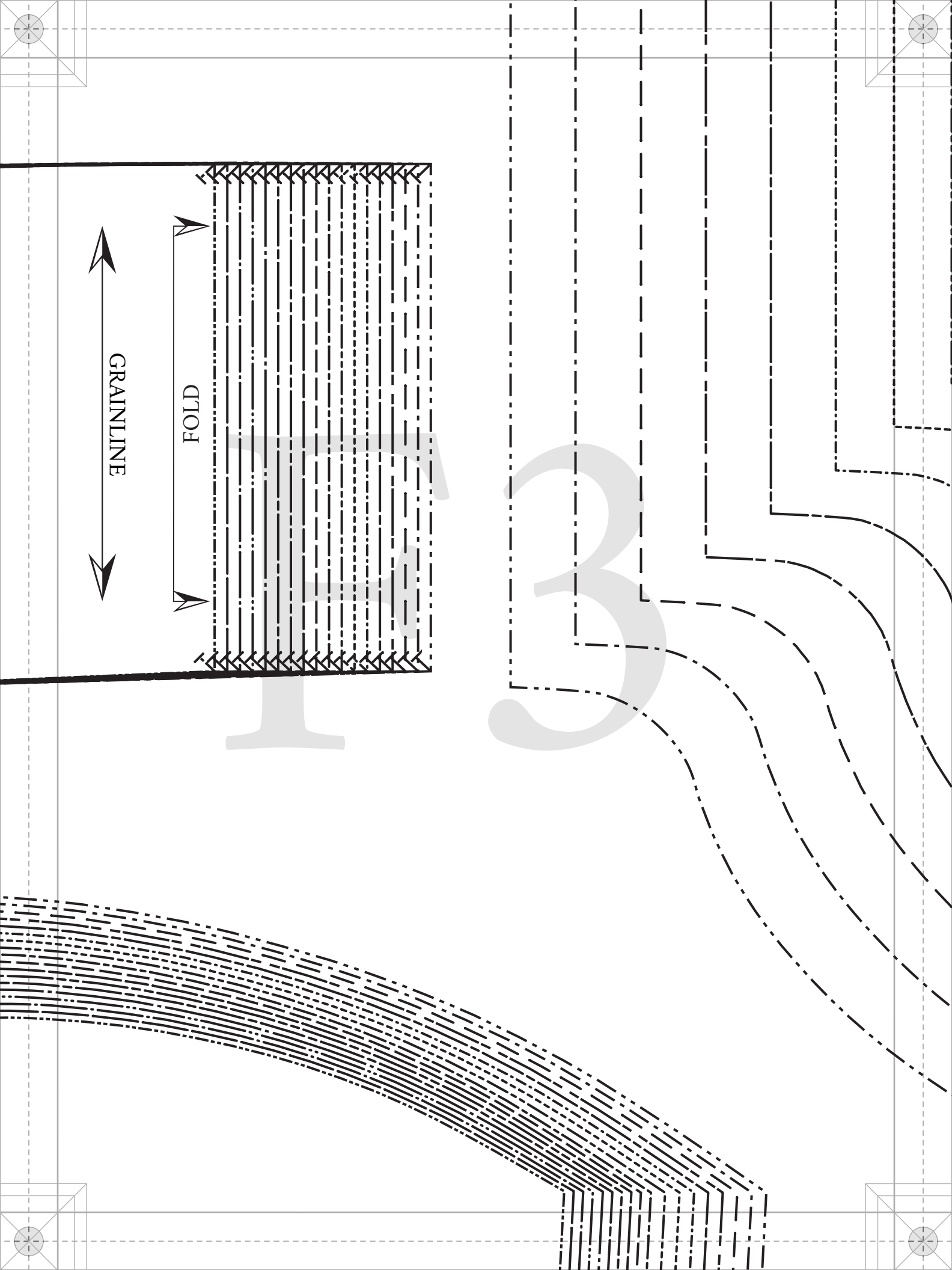

GRAINLINE

FOLD

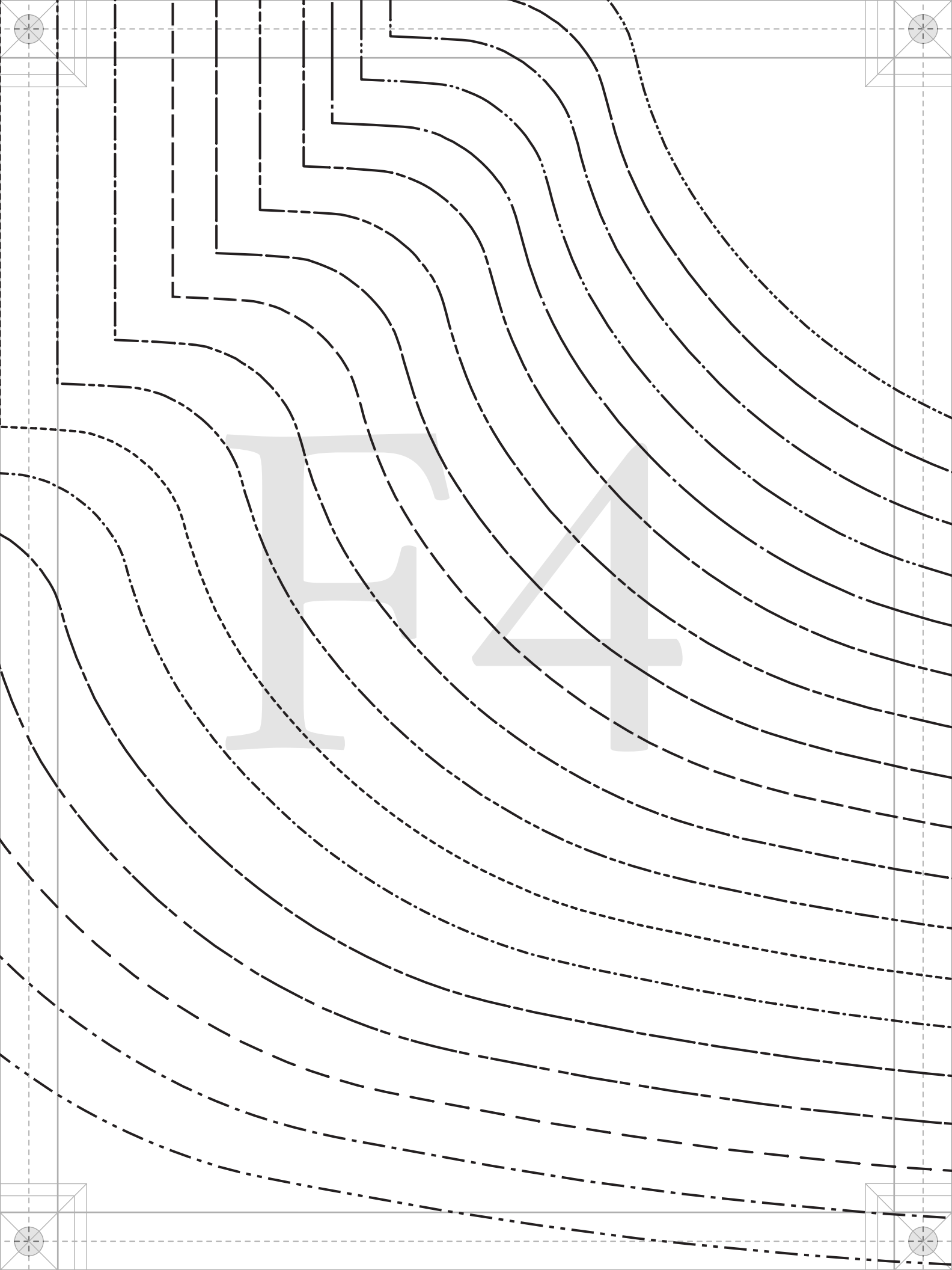

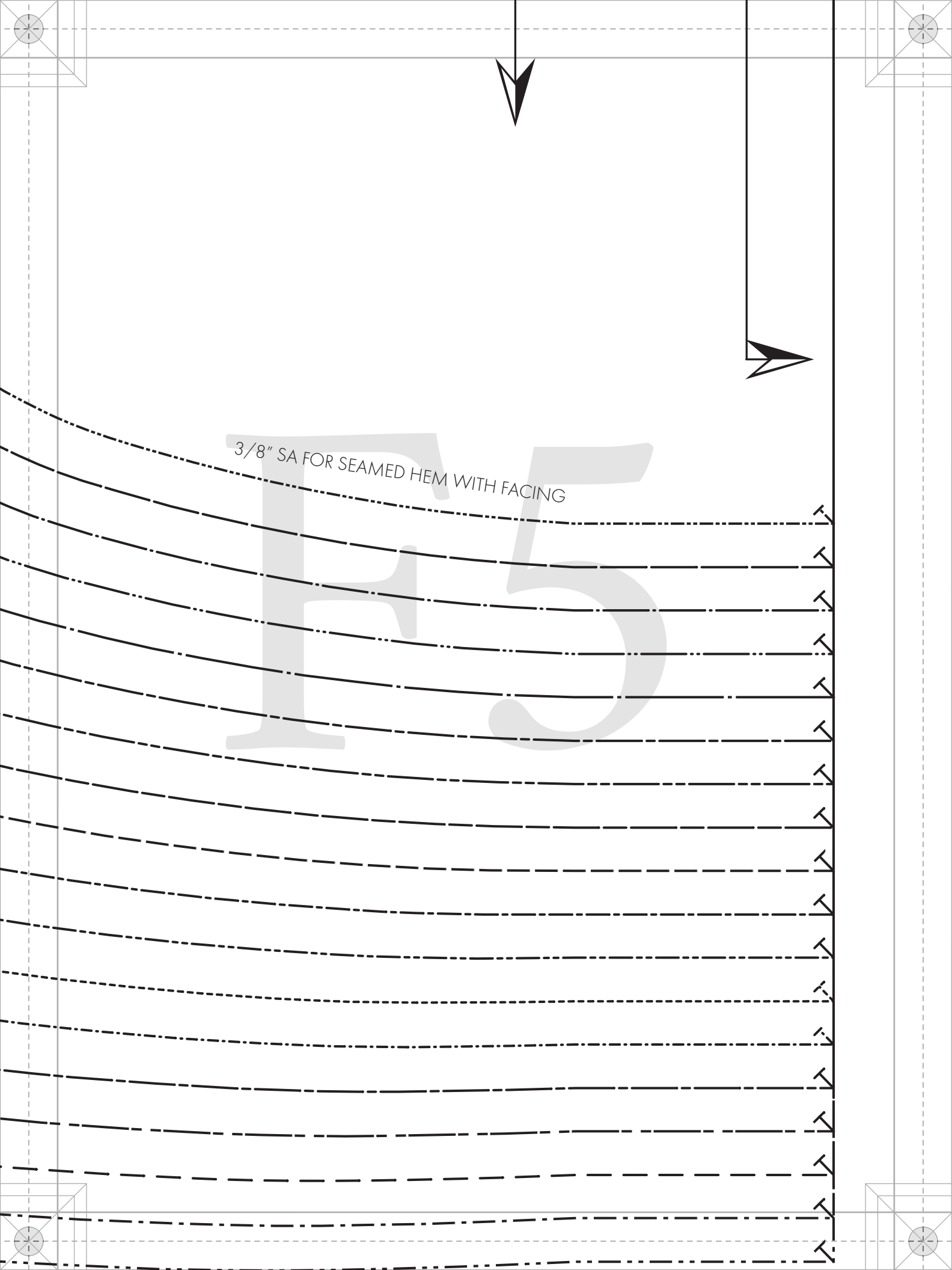

3/8" SA FOR SEAMED HEM WITH FACING

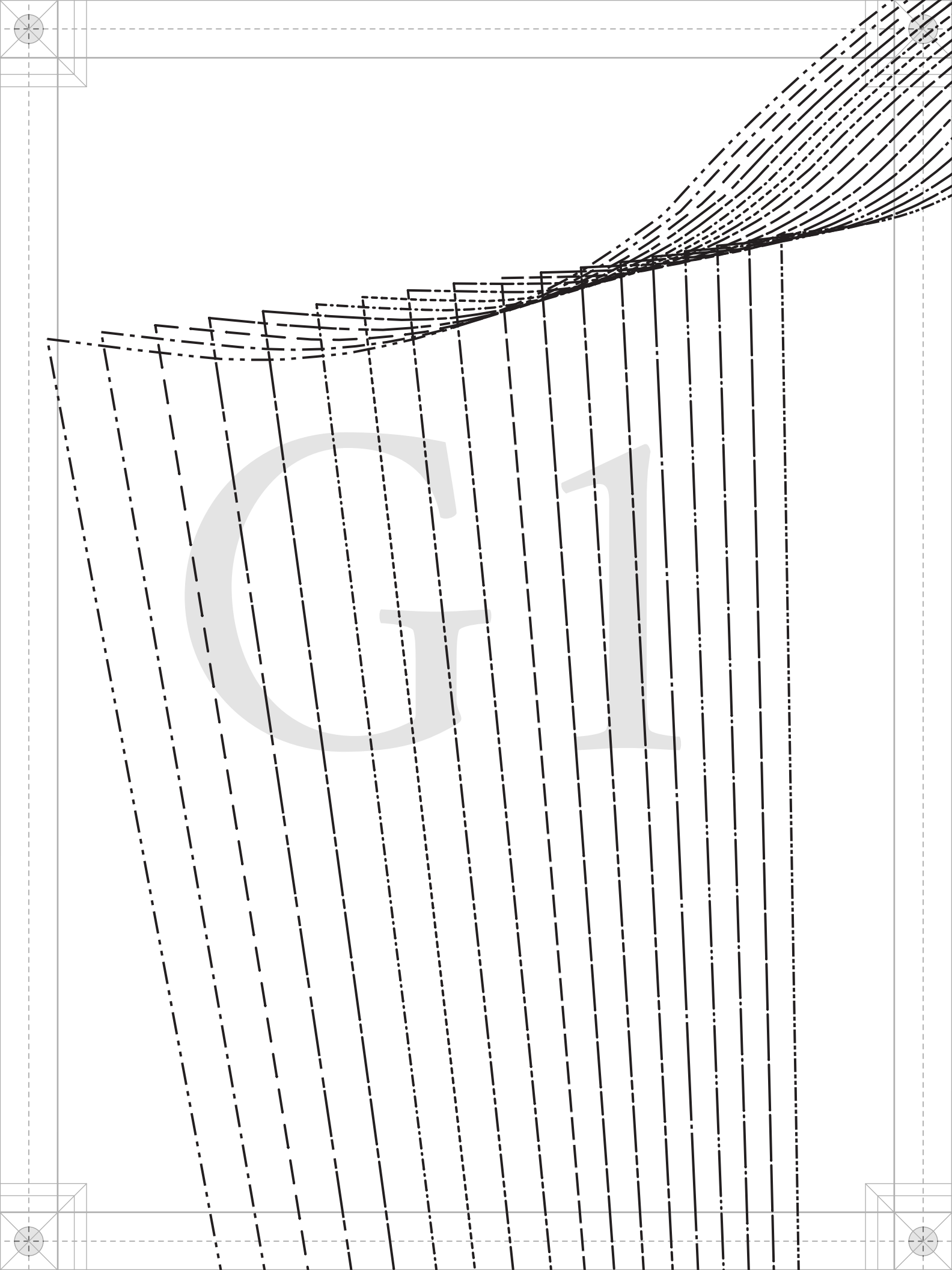



#MoodSavannahPattern

“The Savannah Shacket”
MDF280

F - SLEEVE
FABRIC: CUT 2
MIRRORED PAIR

GRAINLINE



Size Line Key

- SIZE 00
- SIZE 0
- SIZE 2
- SIZE 4
- SIZE 6
- SIZE 8
- SIZE 10
- SIZE 12
- SIZE 14
- SIZE 16
- SIZE 18
- SIZE 20
- SIZE 22
- SIZE 24
- SIZE 26
- SIZE 28
- SIZE 30
- SIZE 32

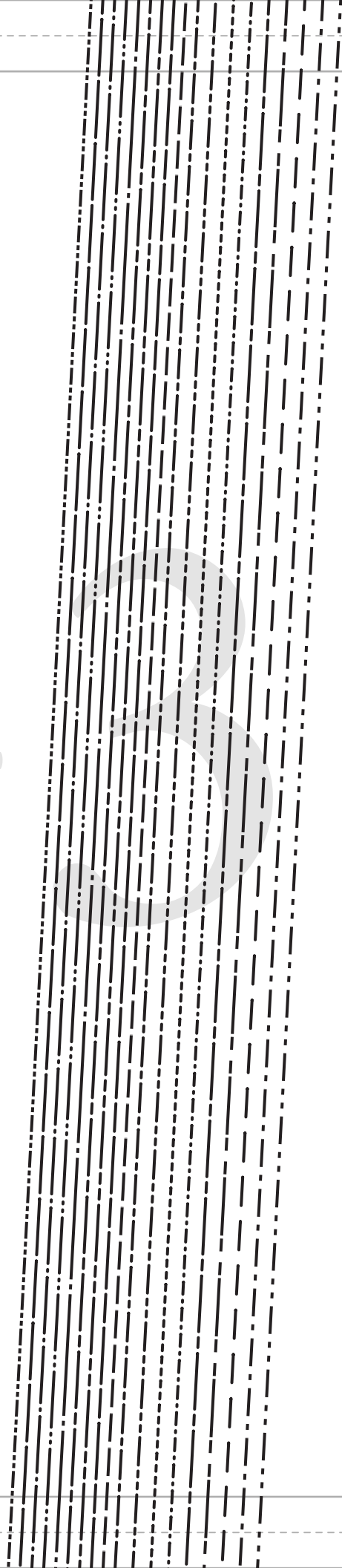

1/2" SA AT SIDE SEAM

GRAINLINE

"The Savannah Shacklet"
MDF280



1/4" SA FOR UPPER EDGE (SERGE OR TURN UNDER)
J - BACK HEM FACING
FABRIC OR CONTRAST: CUT 1
ON FOLD

3/8" SA FOR LOWER E



PATTERNS
BY
Mood
DESIGNER FABRICS
MDF280

#MoodSavannahPattern

“The Savannah Shacklet”
MDF280

H - CUFF
FABRIC: CUT
FUSING: CUT 2
MIRRORED PA

LADIES SIZES 00 TO
1/2" seam allowances
included unless stated otherwise



Handwriting practice sheet featuring the letters 'H', 'I', and 'I' in a large, light gray font. The letters are positioned on a set of slanted lines. The first 'H' is on the left, the second 'I' is in the middle, and the third 'I' is on the right. The lines are solid, dashed, and dash-dot, providing a guide for letter height and placement. The page includes a grid of dashed lines and four corner registration marks.

LADIES SIZES 00 TO 32
1/2" seam allowances (SA's)
included unless stated otherwise.

mood SEWCiETY
IN COLLABORATION WITH
PaTternHack.com

H2

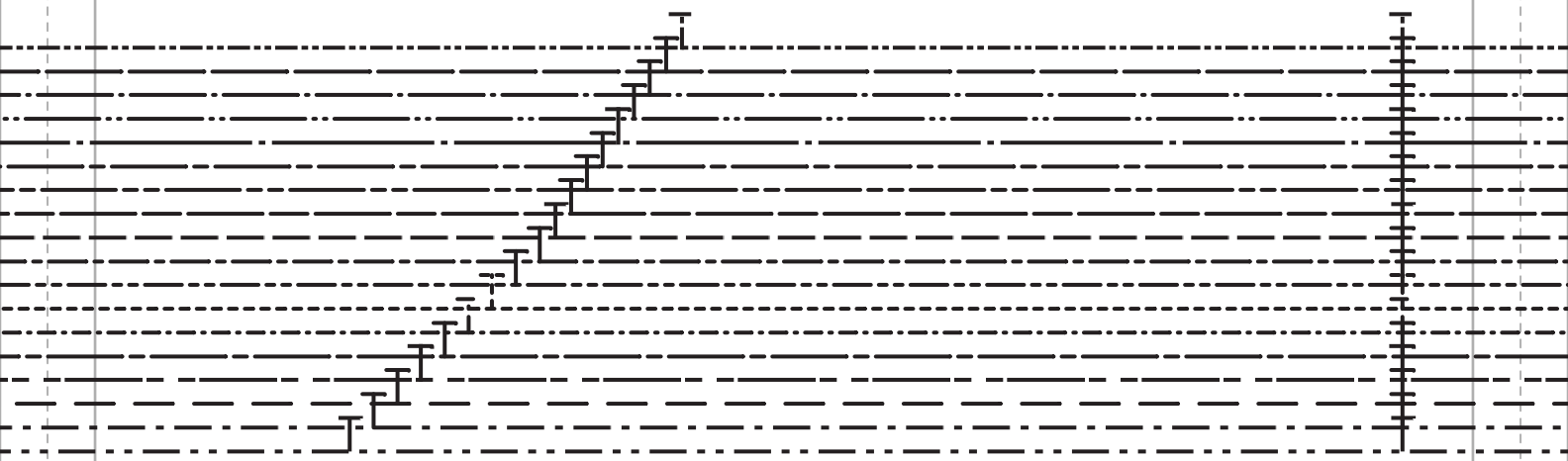

HEM

DOUBLE-TURN HEM FOR SLIT

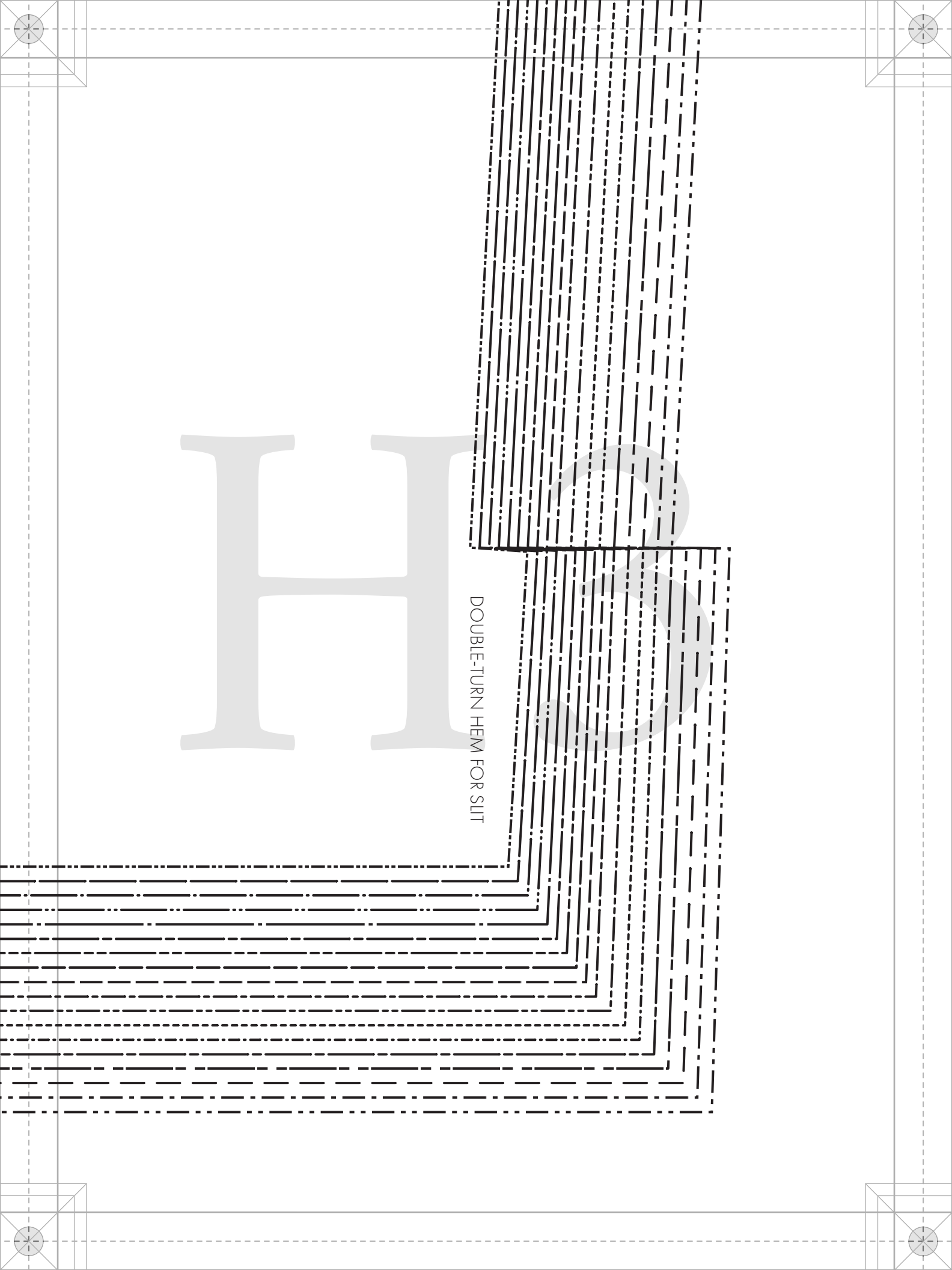

OVER EDGE

UNDER)

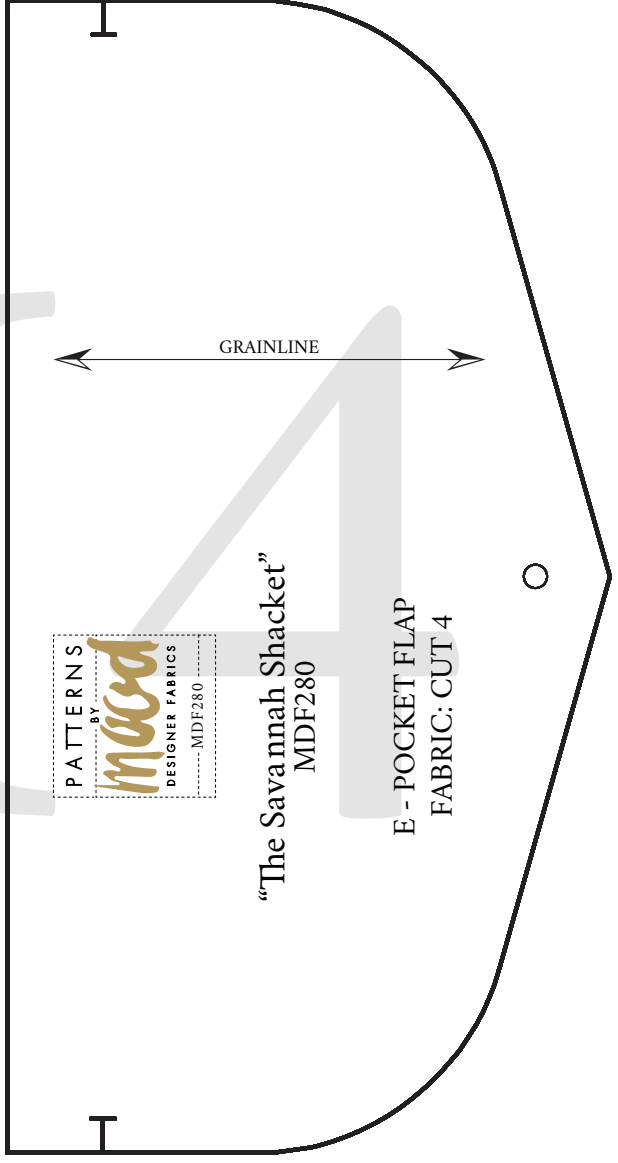

UPP
CUT 4
UT 2 OR 4
ED PAIRS
\$ 00 TO 32
ances (SA's)
ated otherwise.

GRAINLINE

