

TOP
SEW
.RU

брюки
Мария412
@topsew
#Maria412
admin@topsew.ru

размер 58
рост 175-180 см



схема склеивания листов







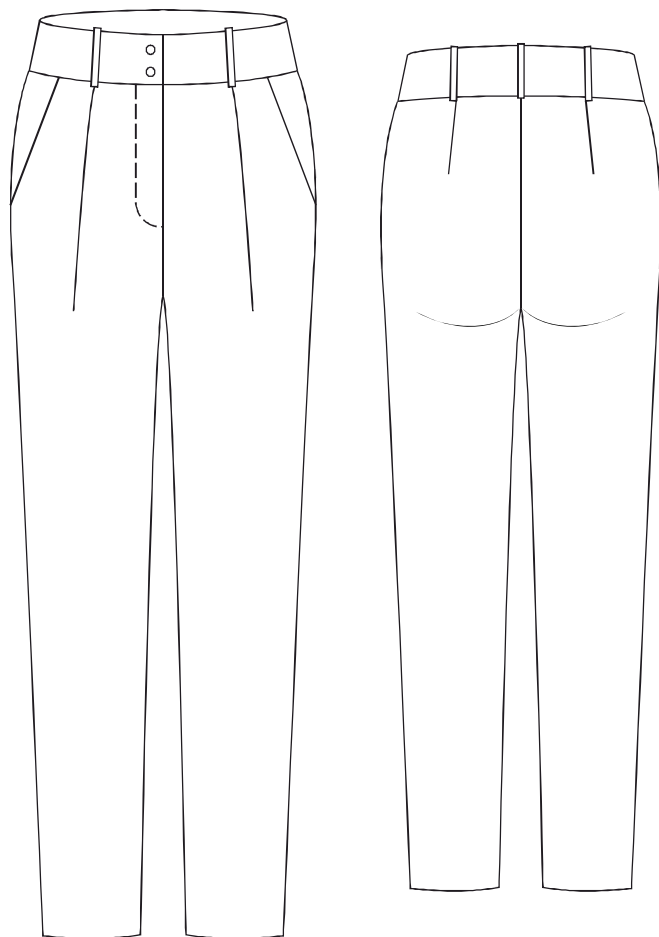
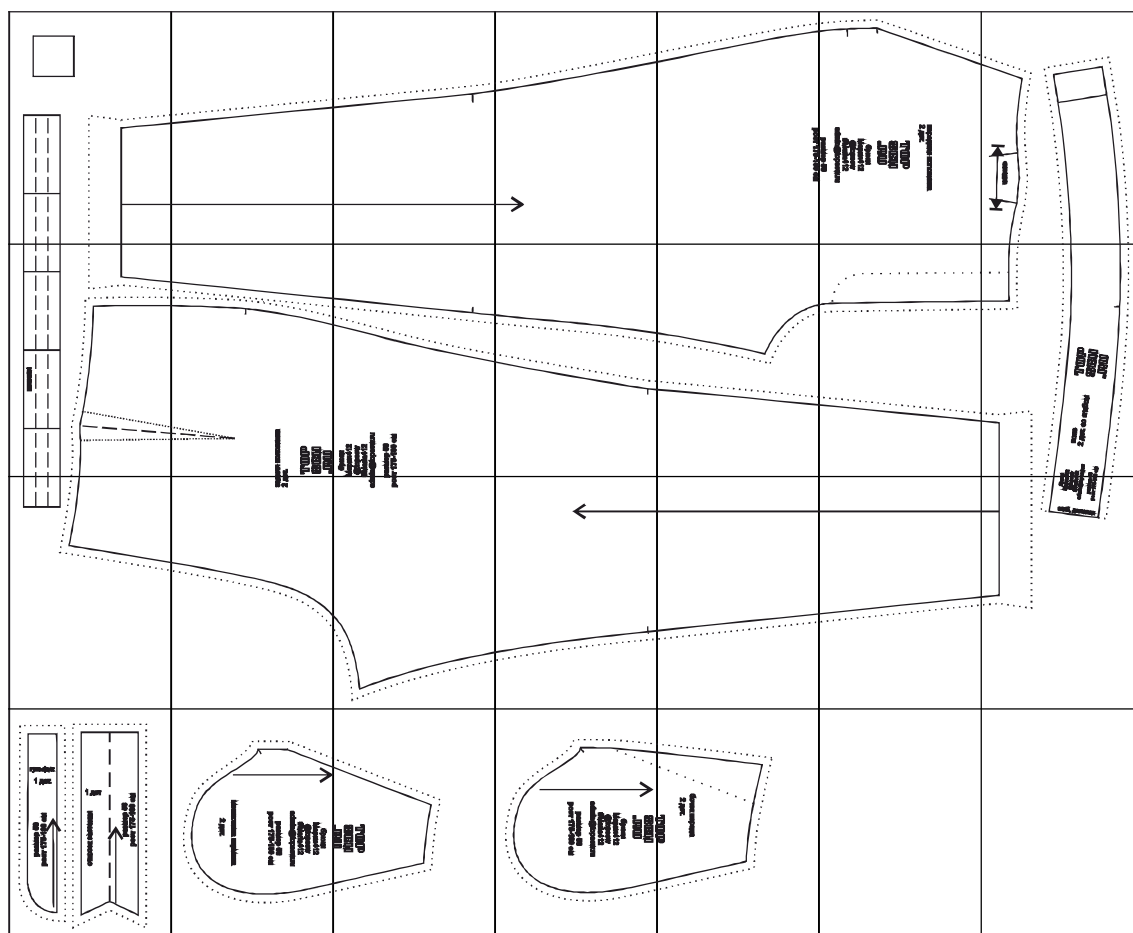
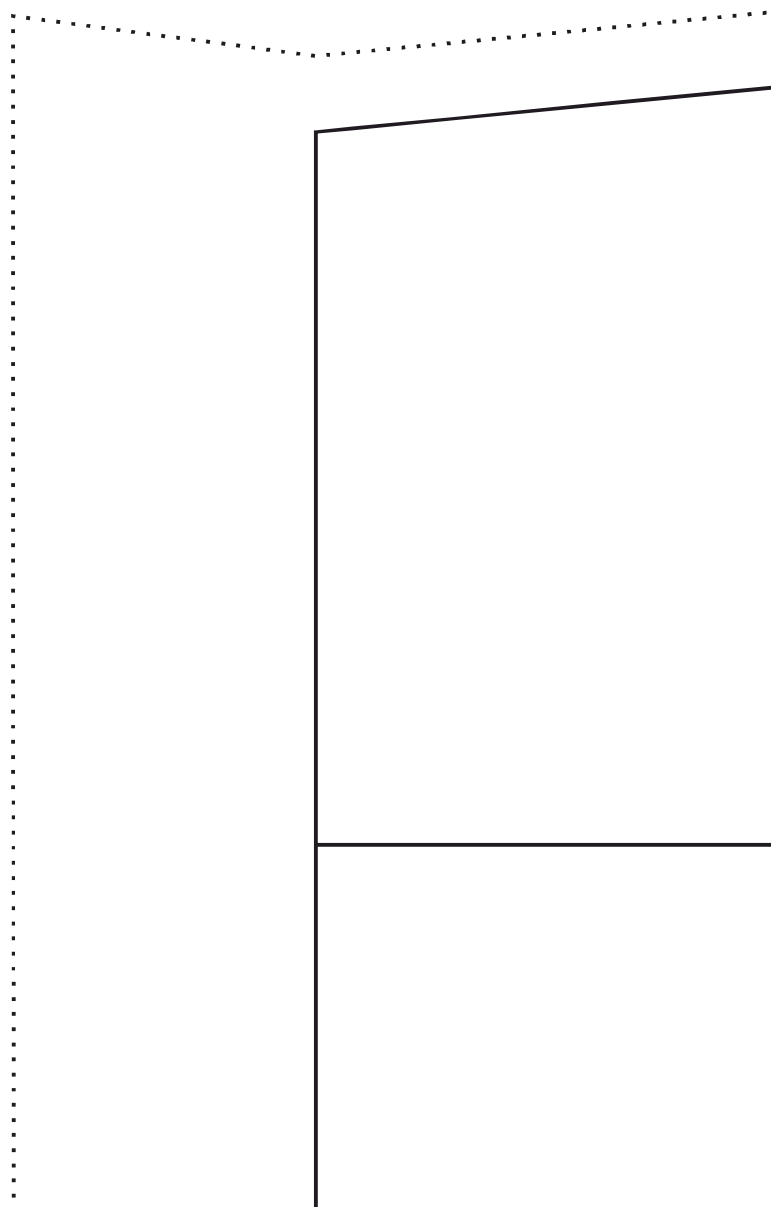
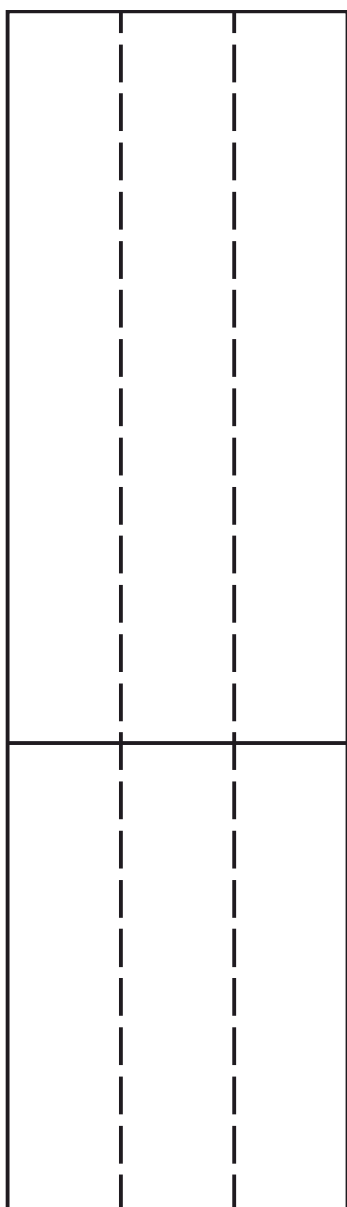
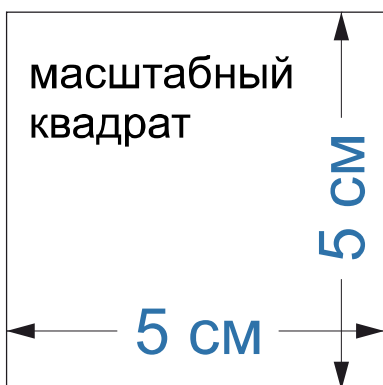
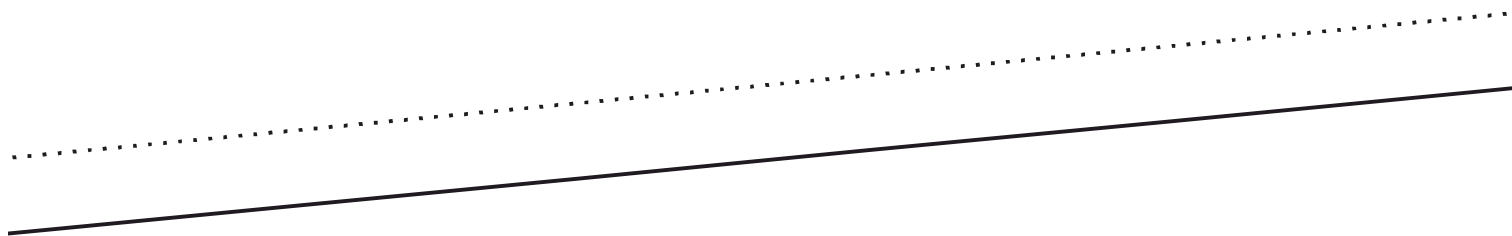
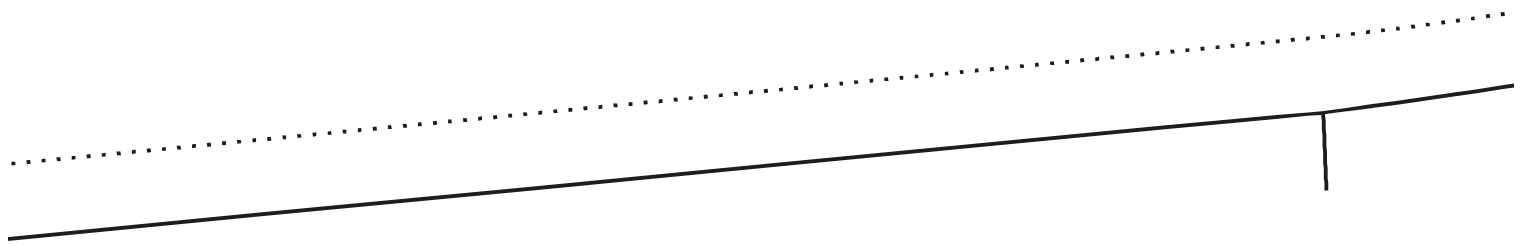

(4, 1)

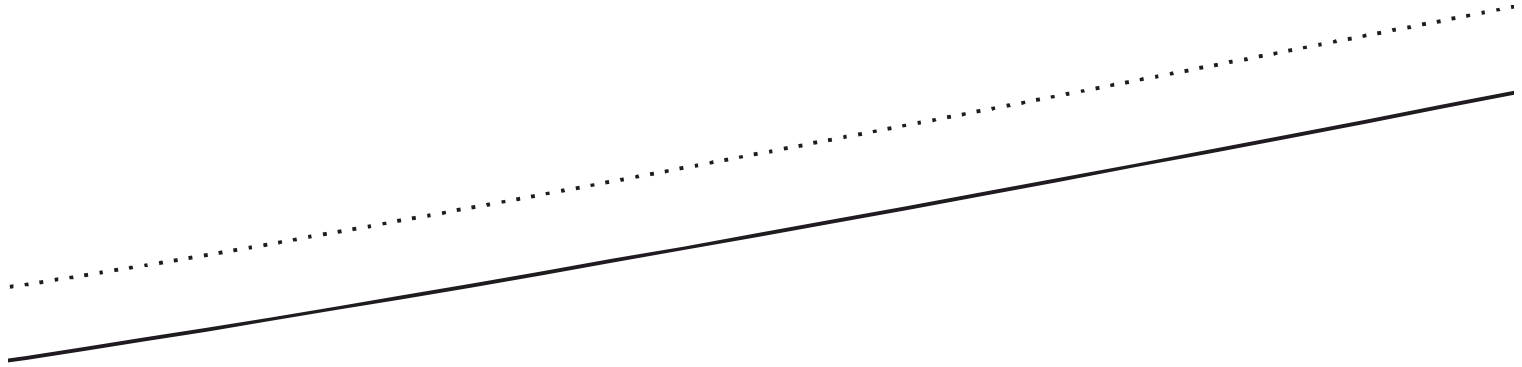

+

+

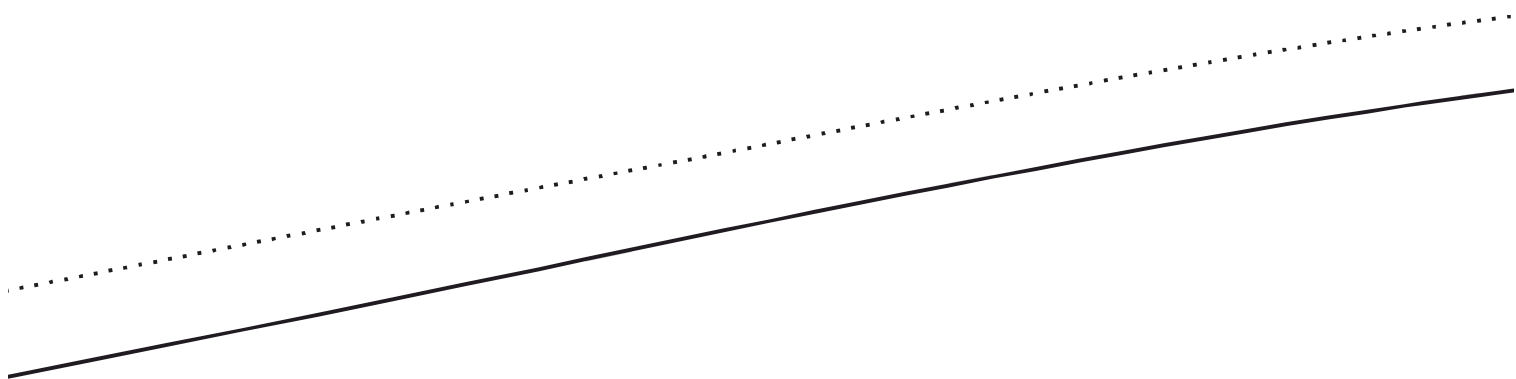

передняя половинка
2 дет.

ТЮДР
SSEM
_RUD

брюки

Мария412

@topsew

#Maria412

admin@topsew.ru

размер 58

порт 175-180 см

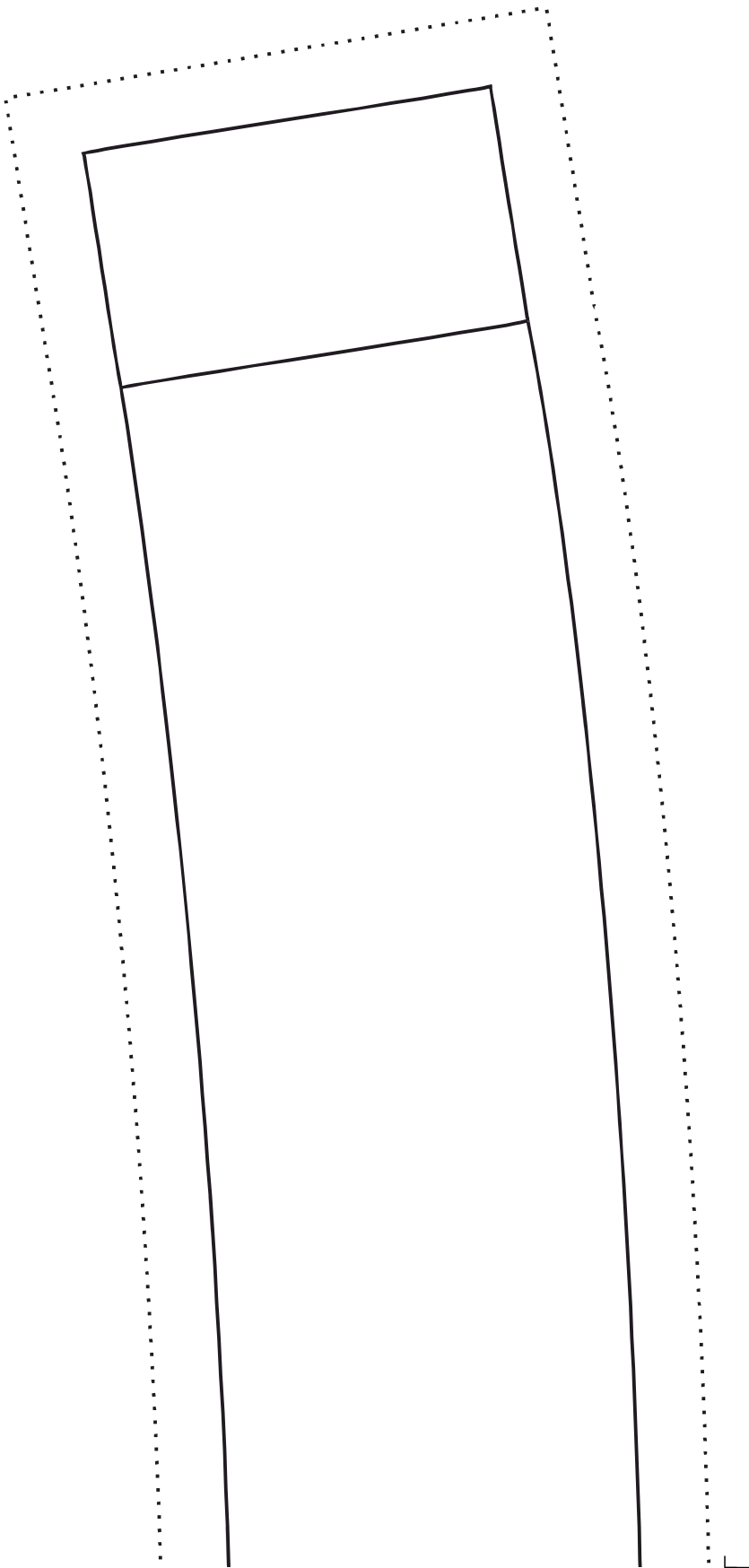
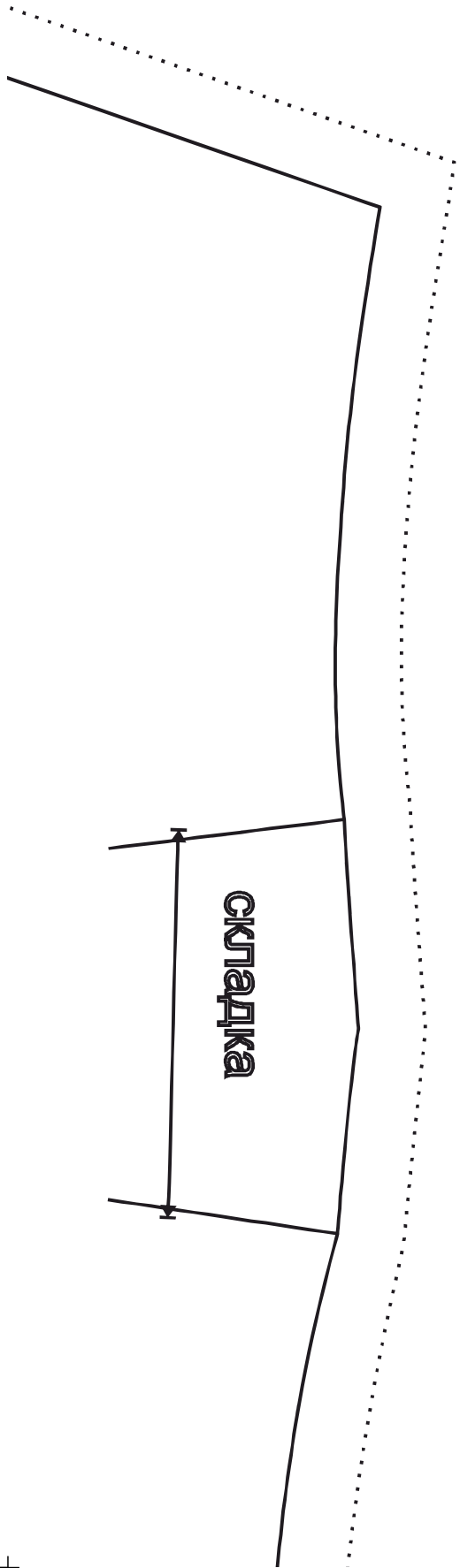

ШЛЕВКИ		

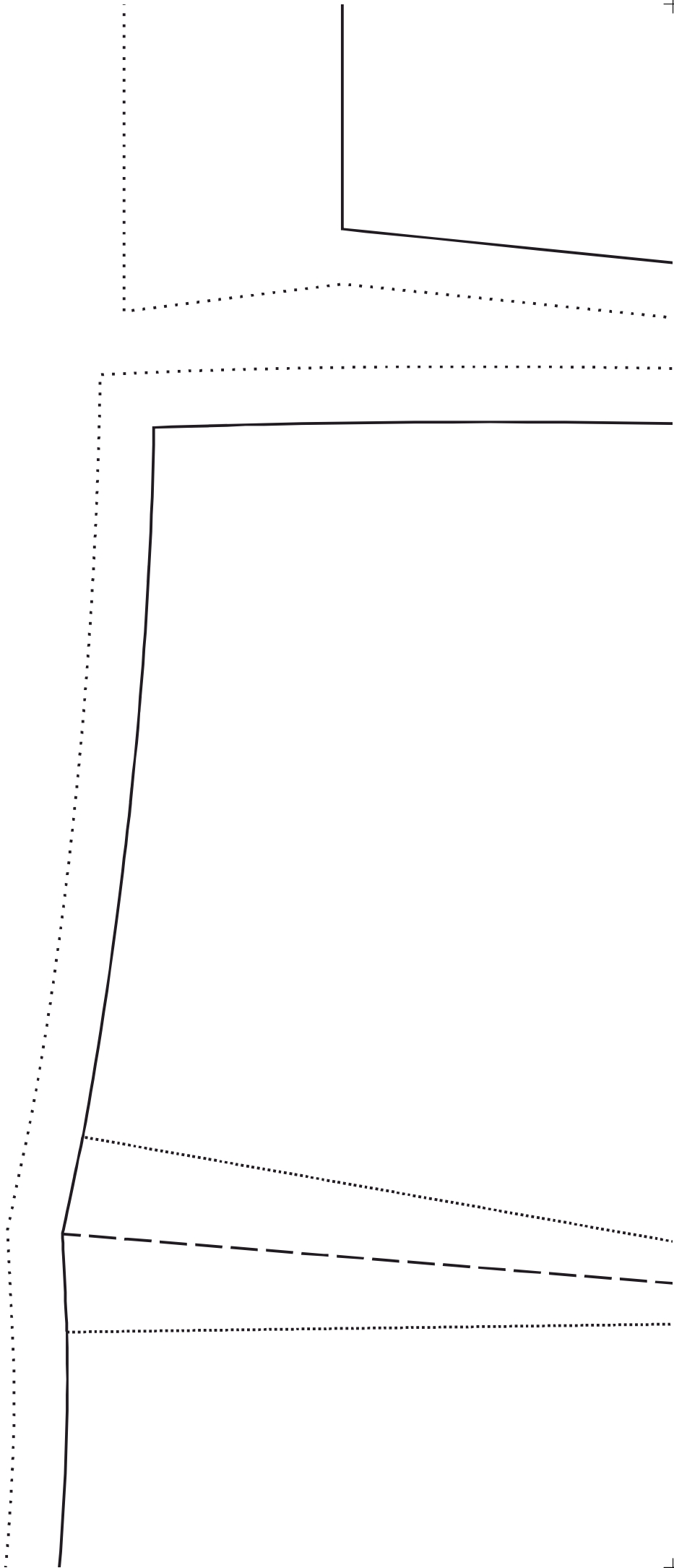

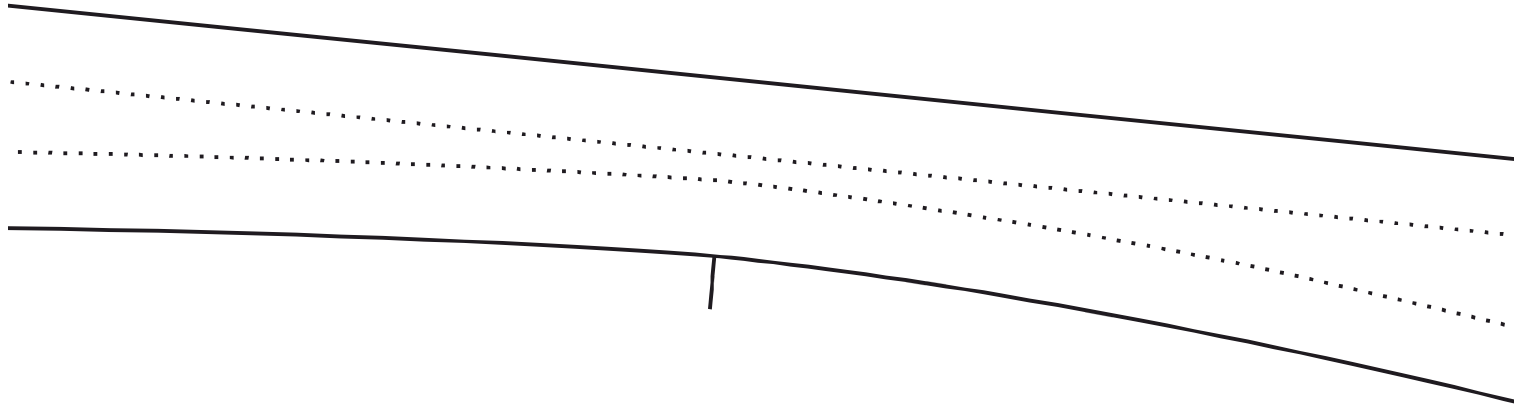

НЯЯ ПОЛОВИНКА

ЭТ.

ТОВА
 СЕМ
 .РУ

брюки
Мария412
@topsew
#Maria412
in@topsew.ru

размер 58
Т 175-180 см

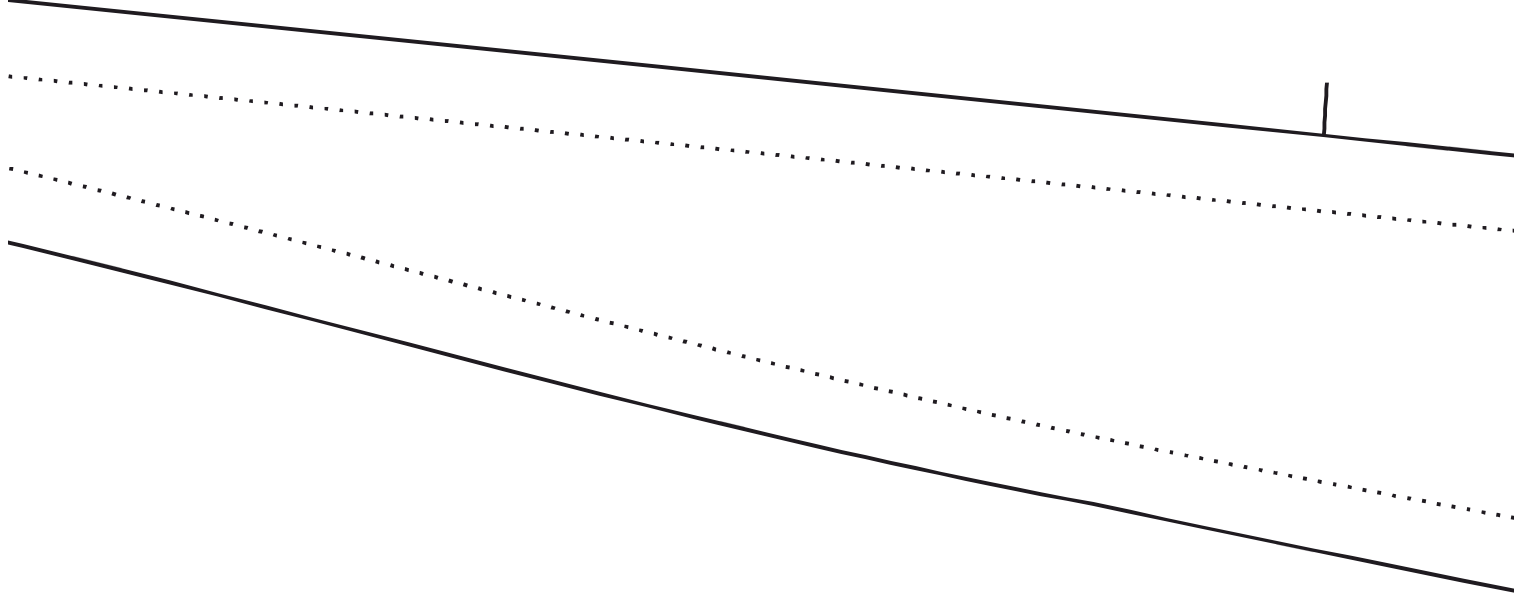

(4, 2)

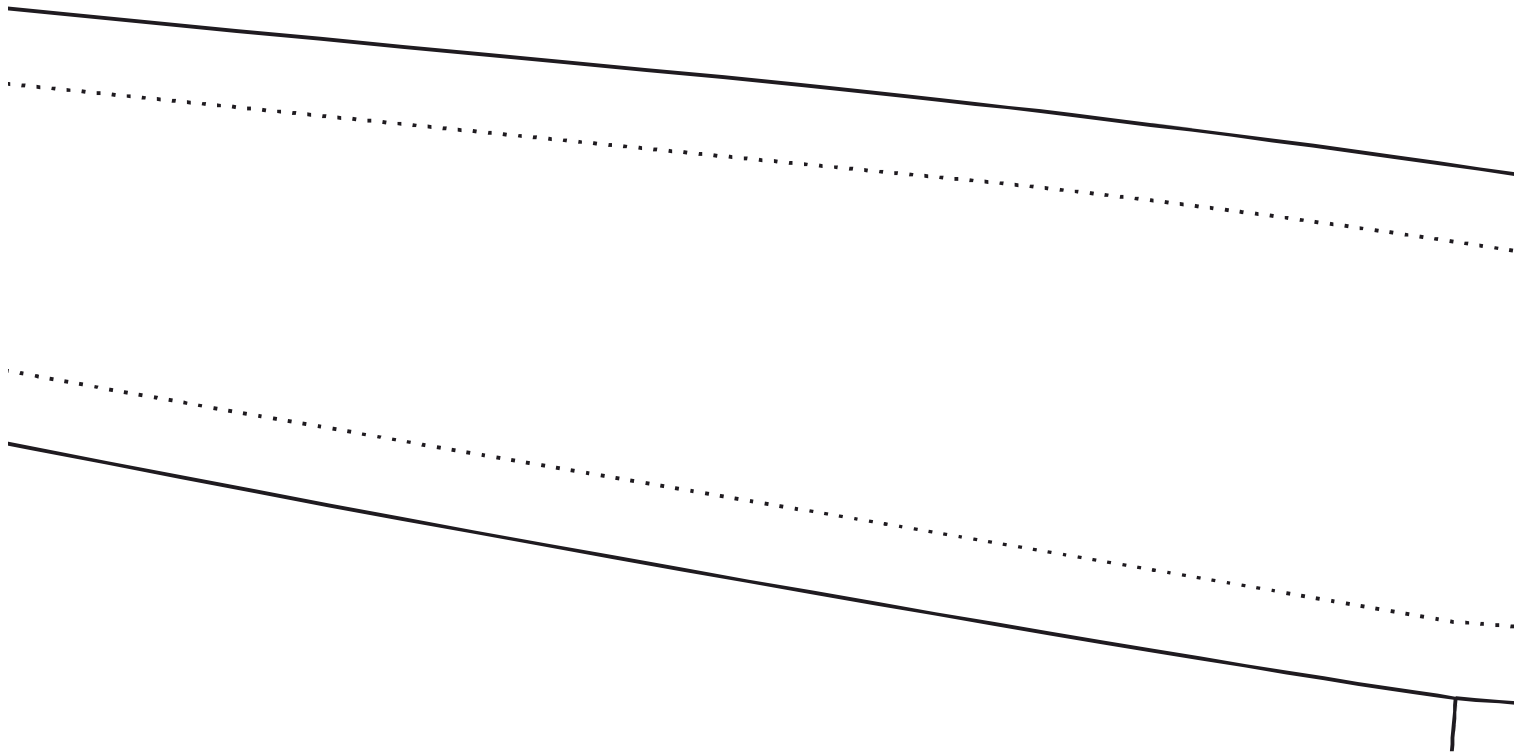

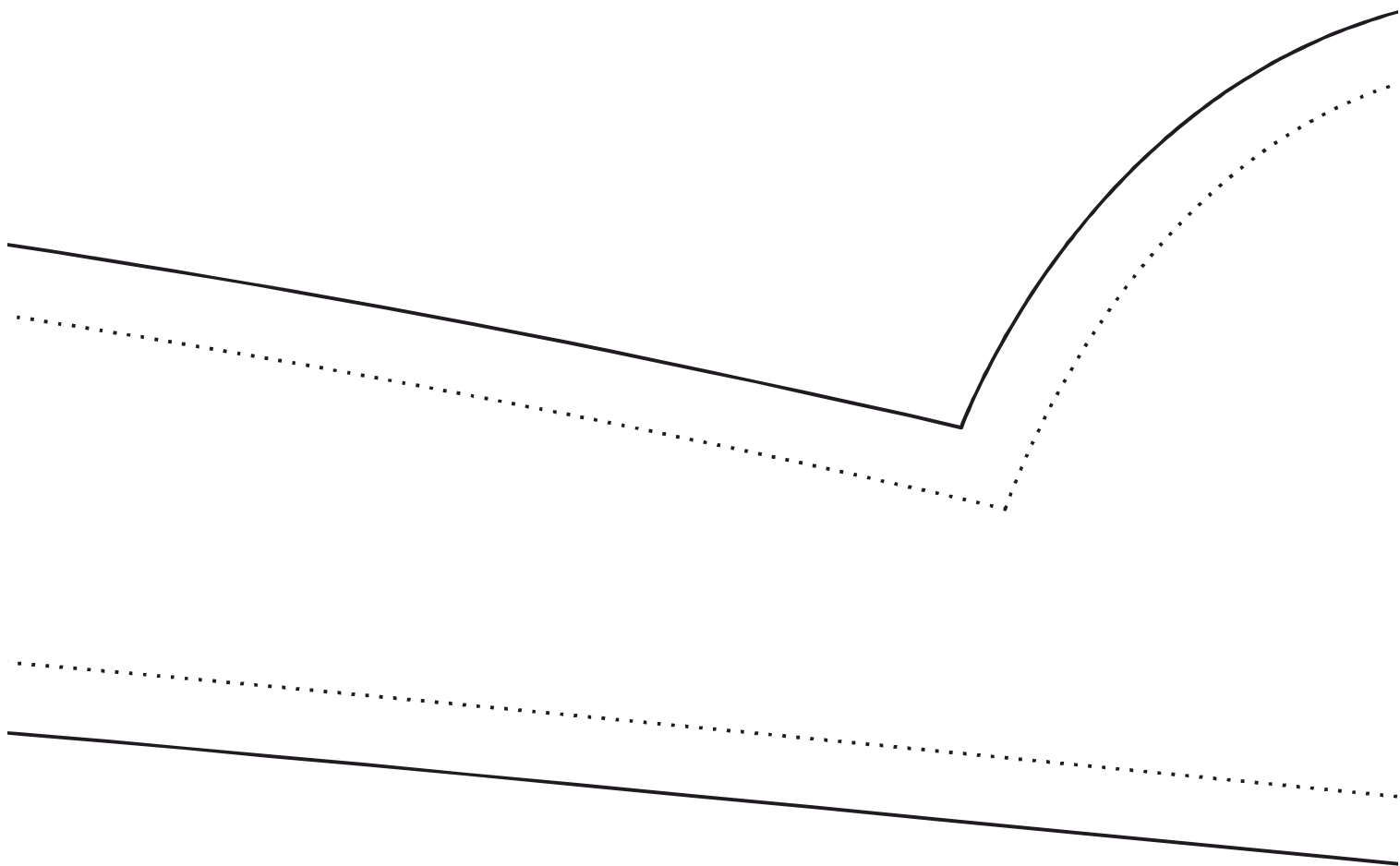

(6, 2)

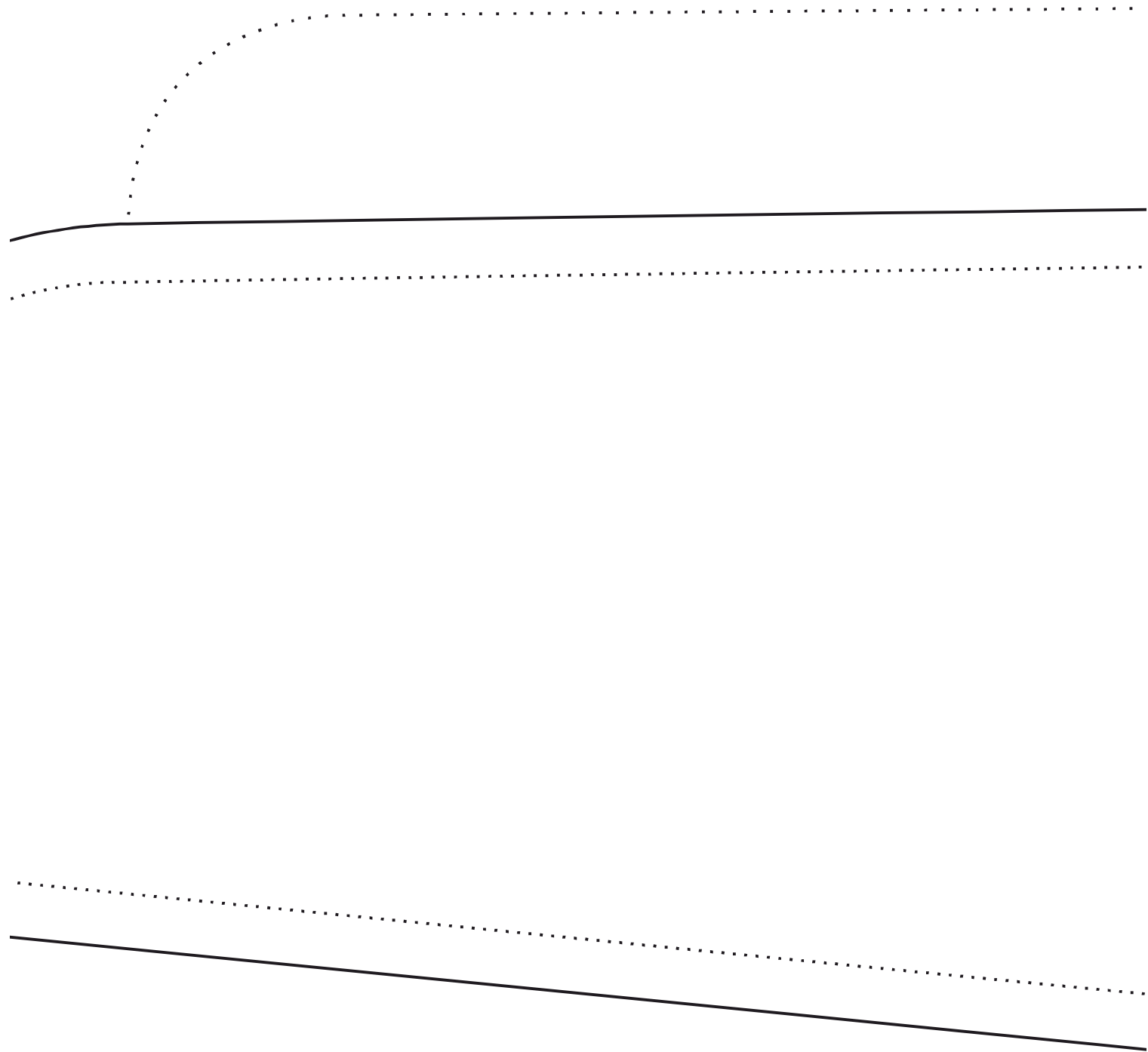

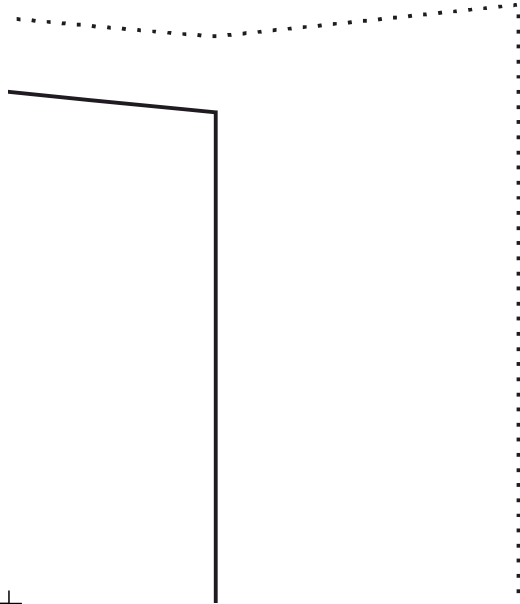
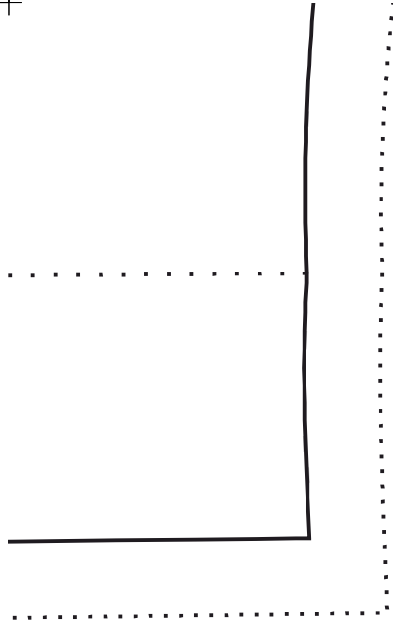

И
12
ew.ru
8
0 см

ПОЯС
2 ДЕТ. СО СГИБОМ

TOP
SEW
-BUD

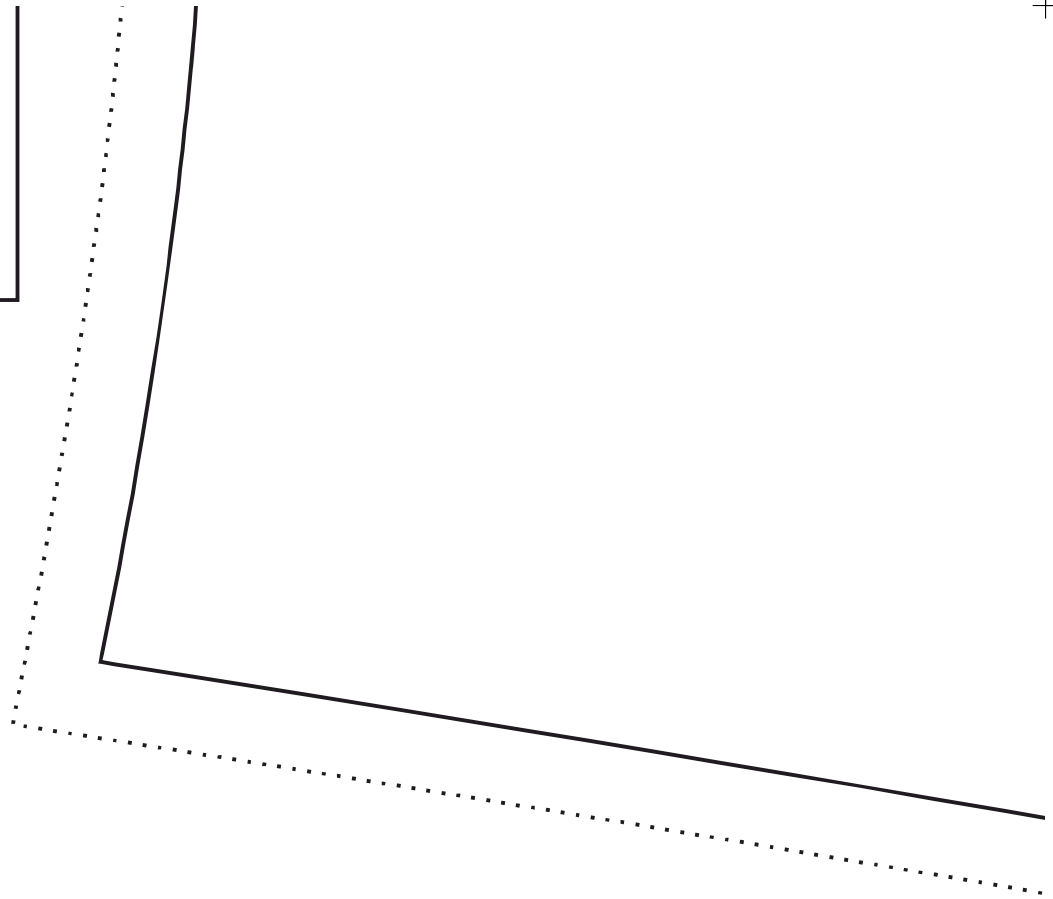
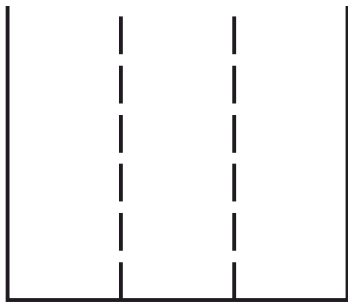

зад
2 д€

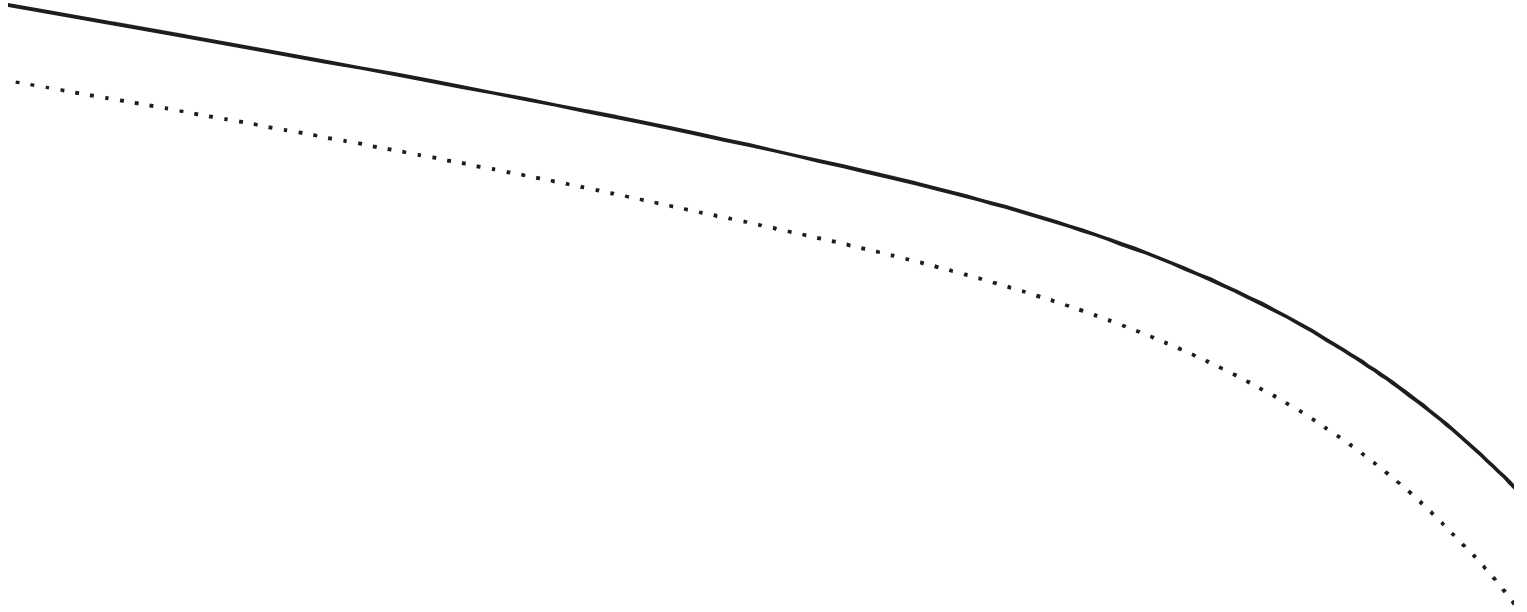

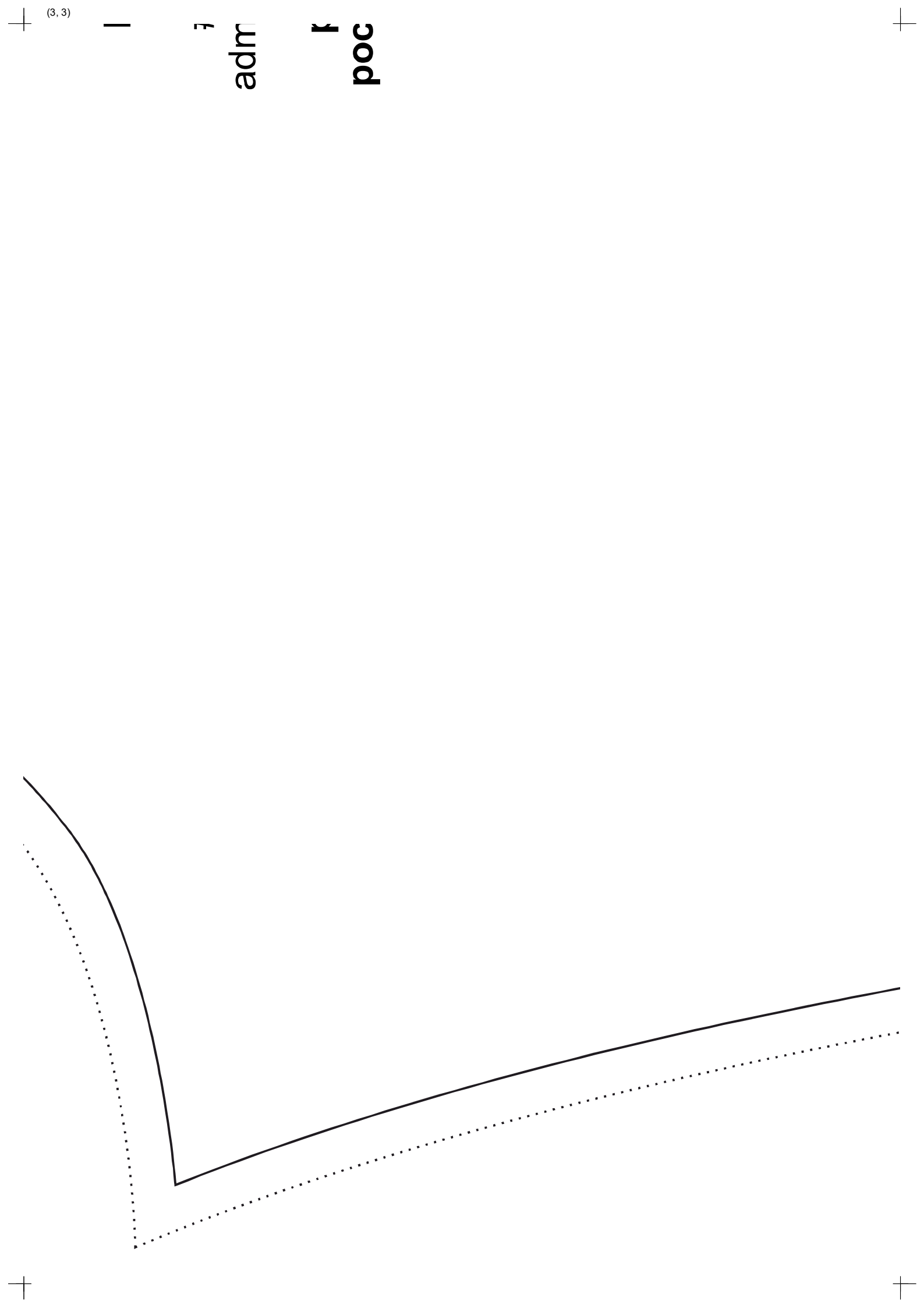

(3, 3)

adm

k

poc

(4, 3)

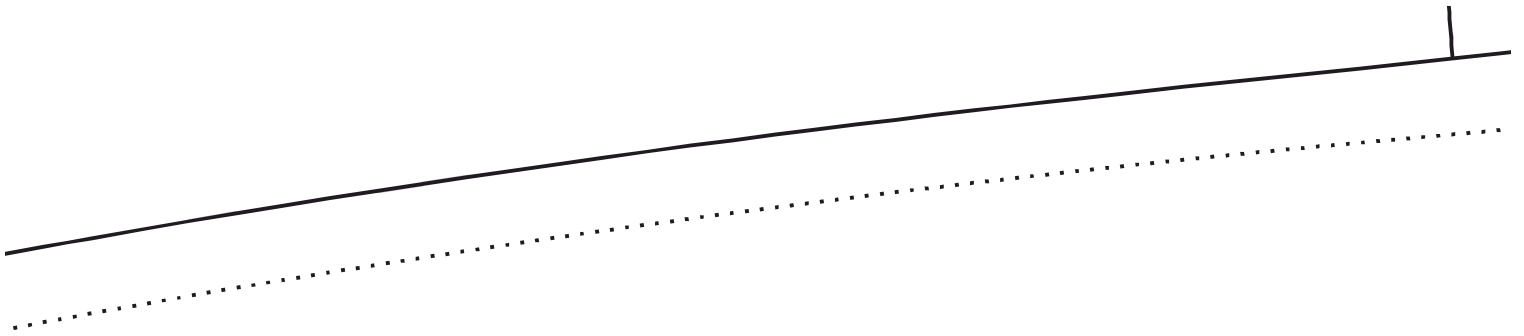

(5, 3)

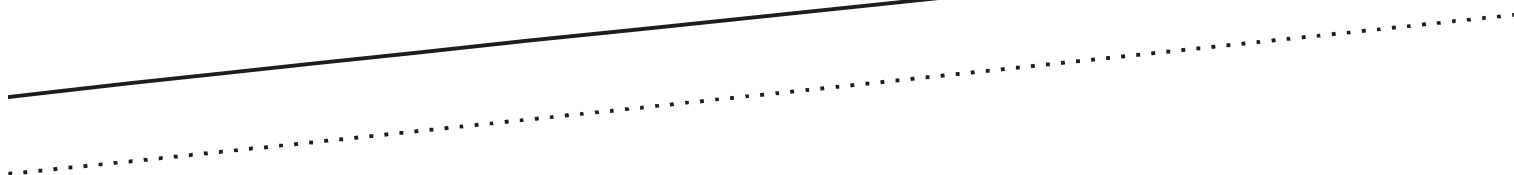

(6, 3)

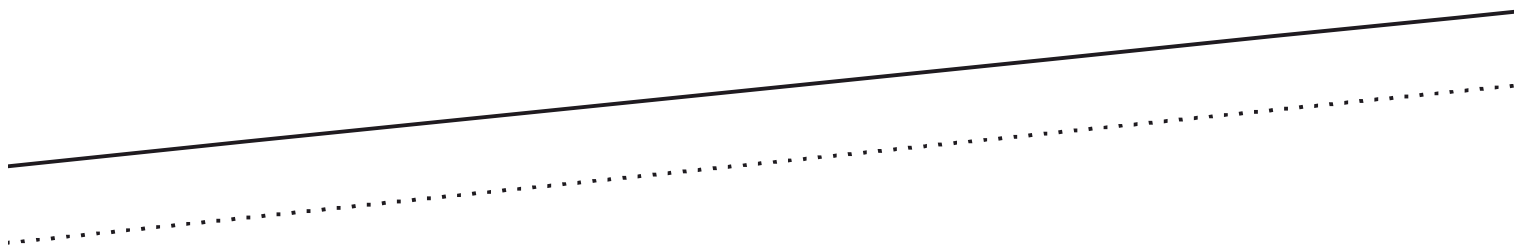

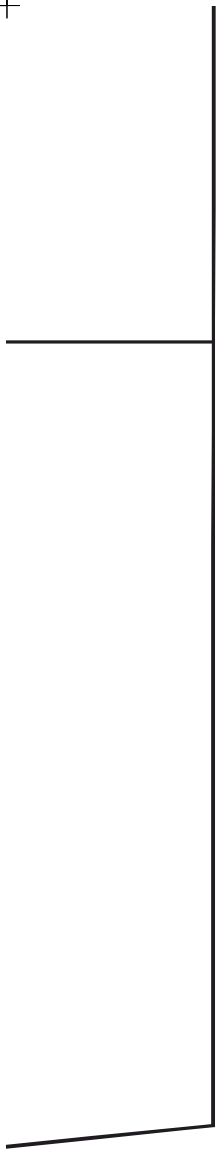

СГИБ, ДОЛЕВАЯ

брюк
Мария4
@topse
#Maria4
admin@tops

**размер 5
рост 175-180**

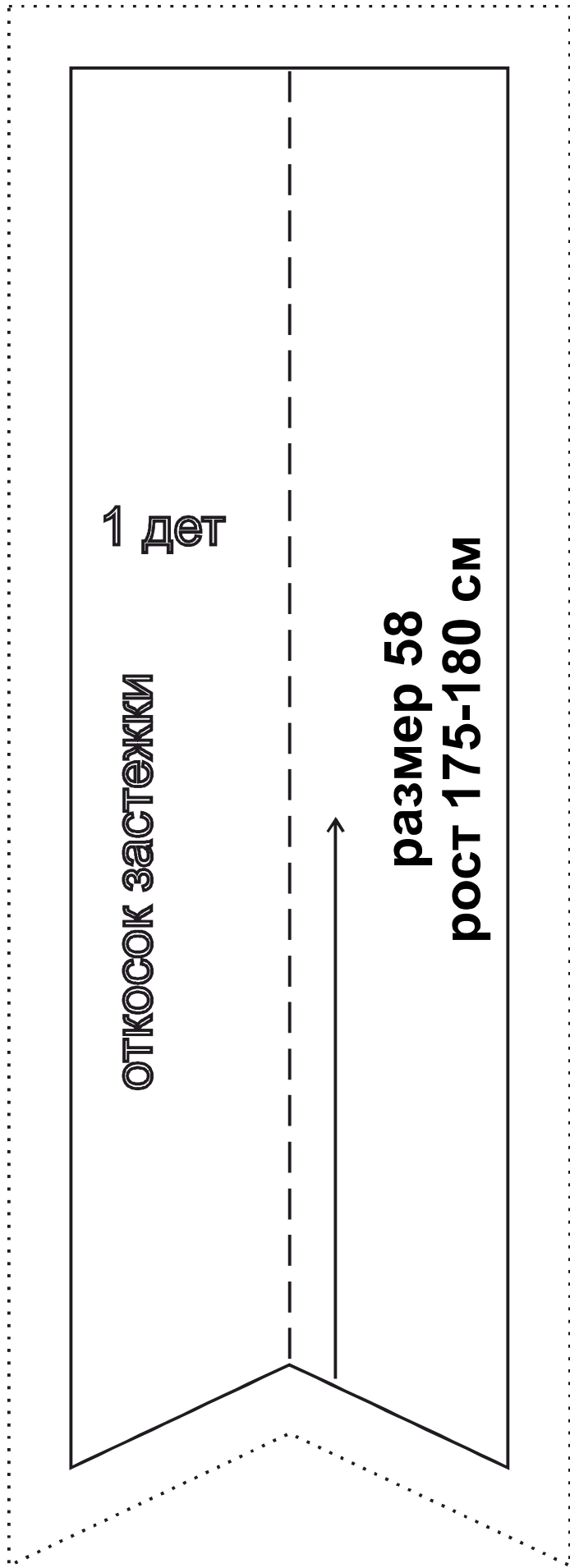
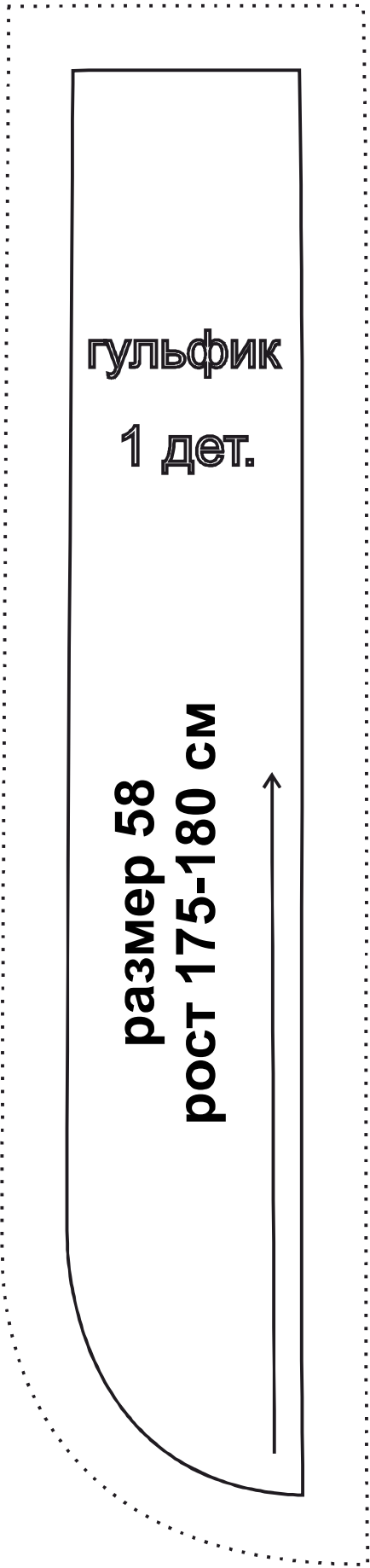

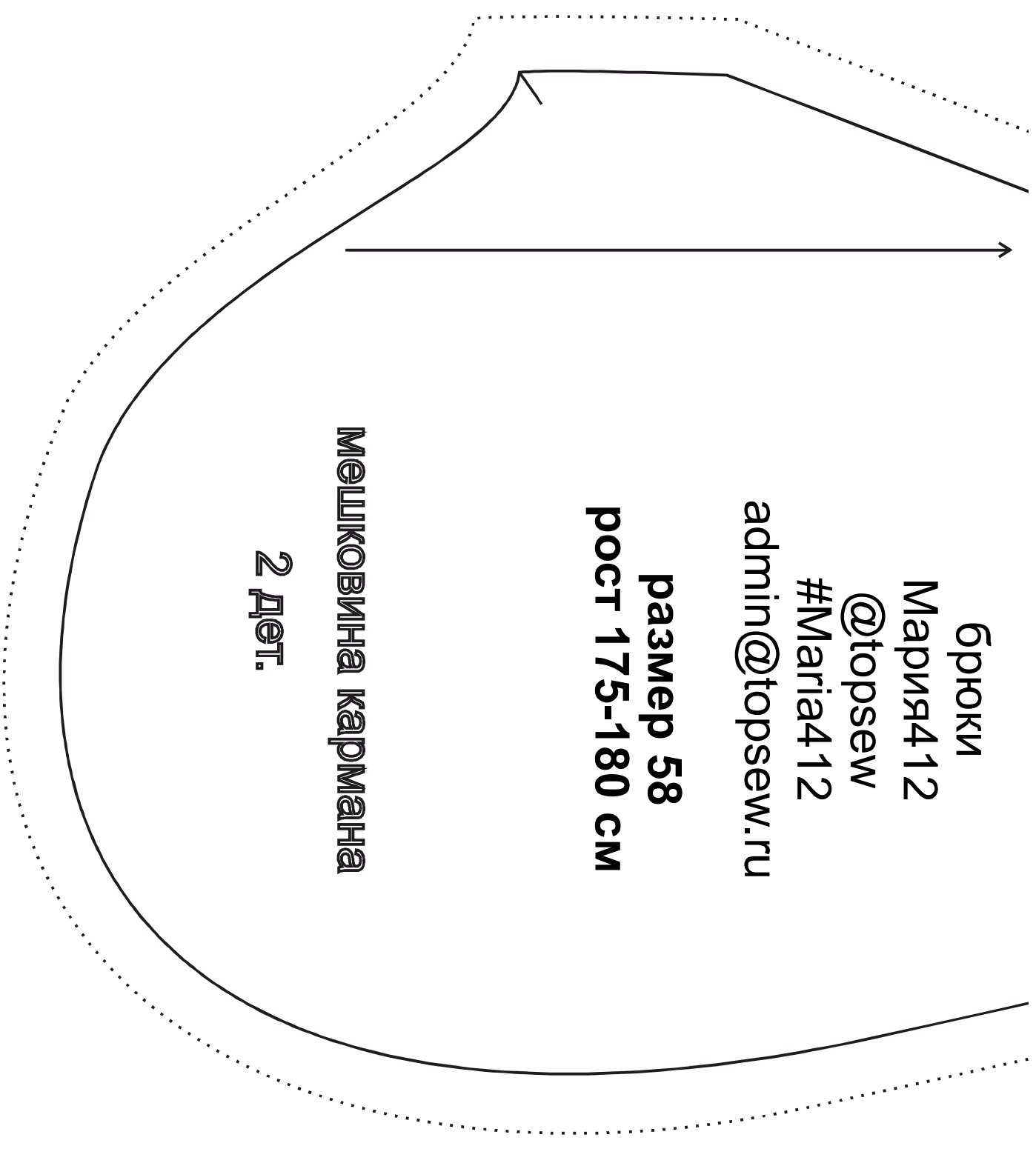

брюки

Мария412

@topsew

#Maria412

admin@topsew.ru

размер 58

рост 175-180 см

МЕШКОВИНА кармана

2 дет.

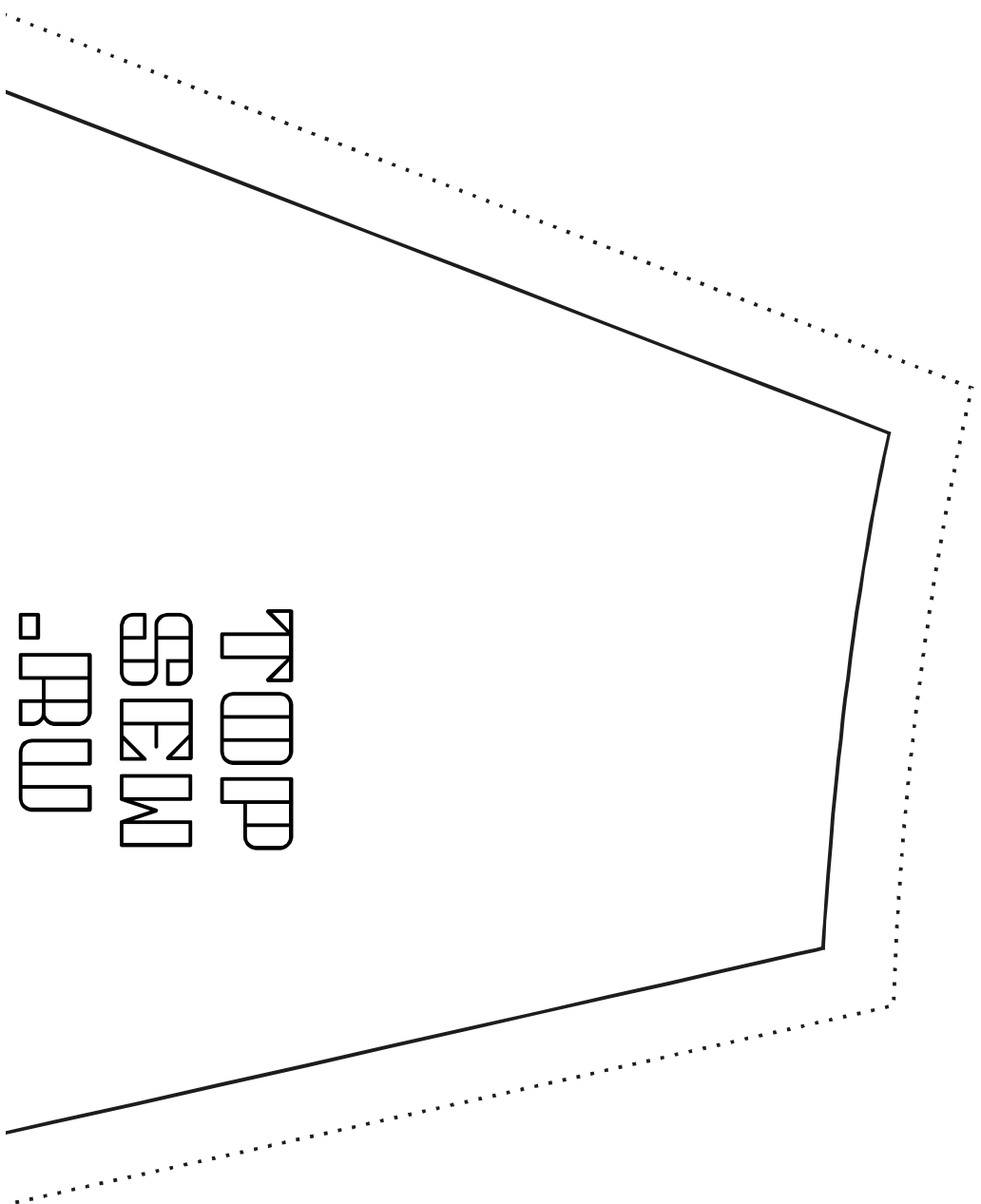

TOP
SEMI
.PRU

СДЕЛМ
_РЮЮ

брюки

Мария412

@topsew

#Maria412

admin@topsew.ru

размер 58

рост 175-180 см

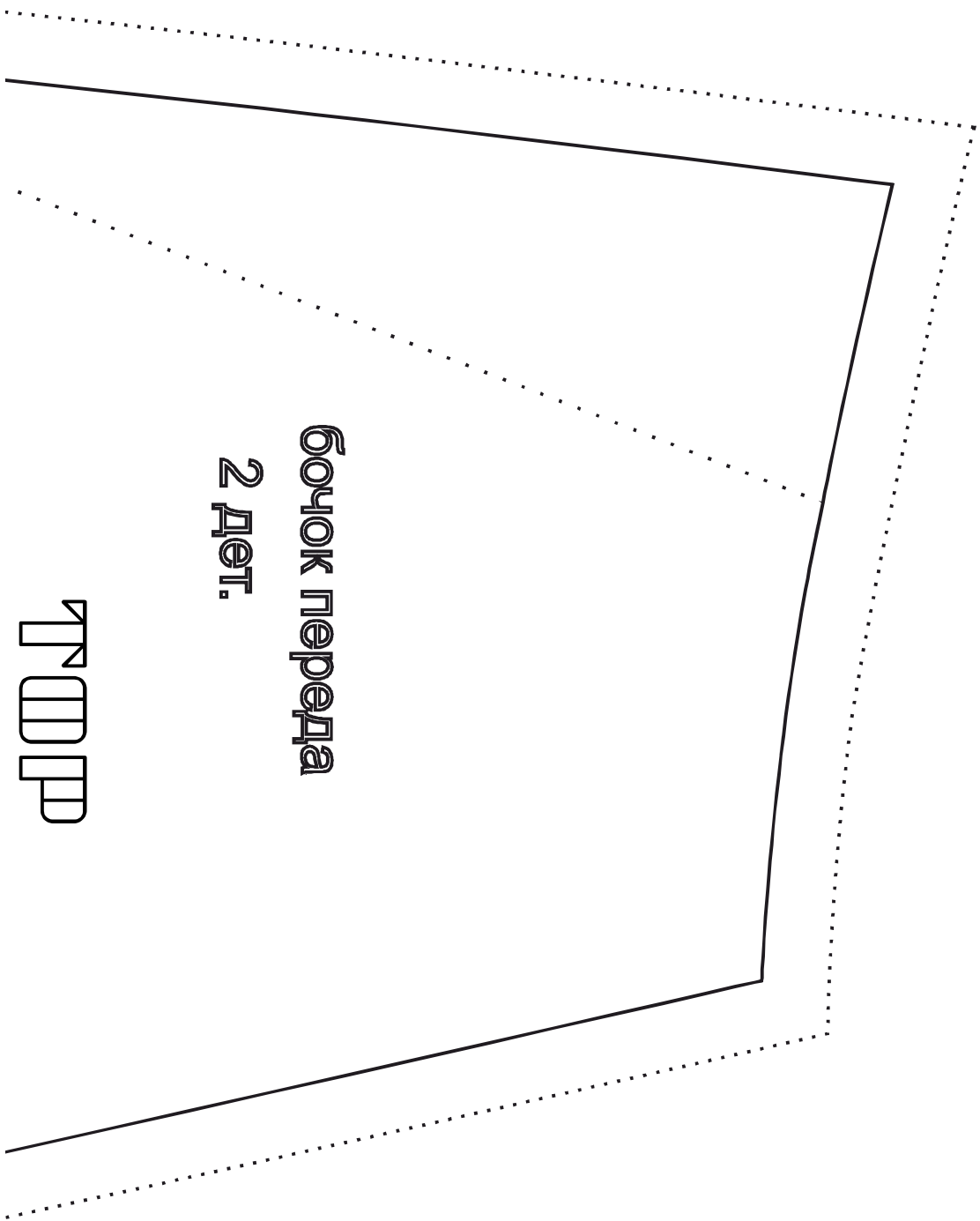

Боуок перада
2 дѣт.

