

# BESSIE DRESS PATTERN

Use these guides to get started today

---

IN YOUR PRINT MENU, UNDER SIZE OPTIONS, BE SURE TO  
SELECT '**ACTUAL SIZE**', INSTEAD OF 'FIT TO PAGE'

---

**Title:** Bessie Dress  
**Designer:** Posner and Posner  
**Magazine page:** 36



# BESSIE DRESS PATTERN LAYOUT

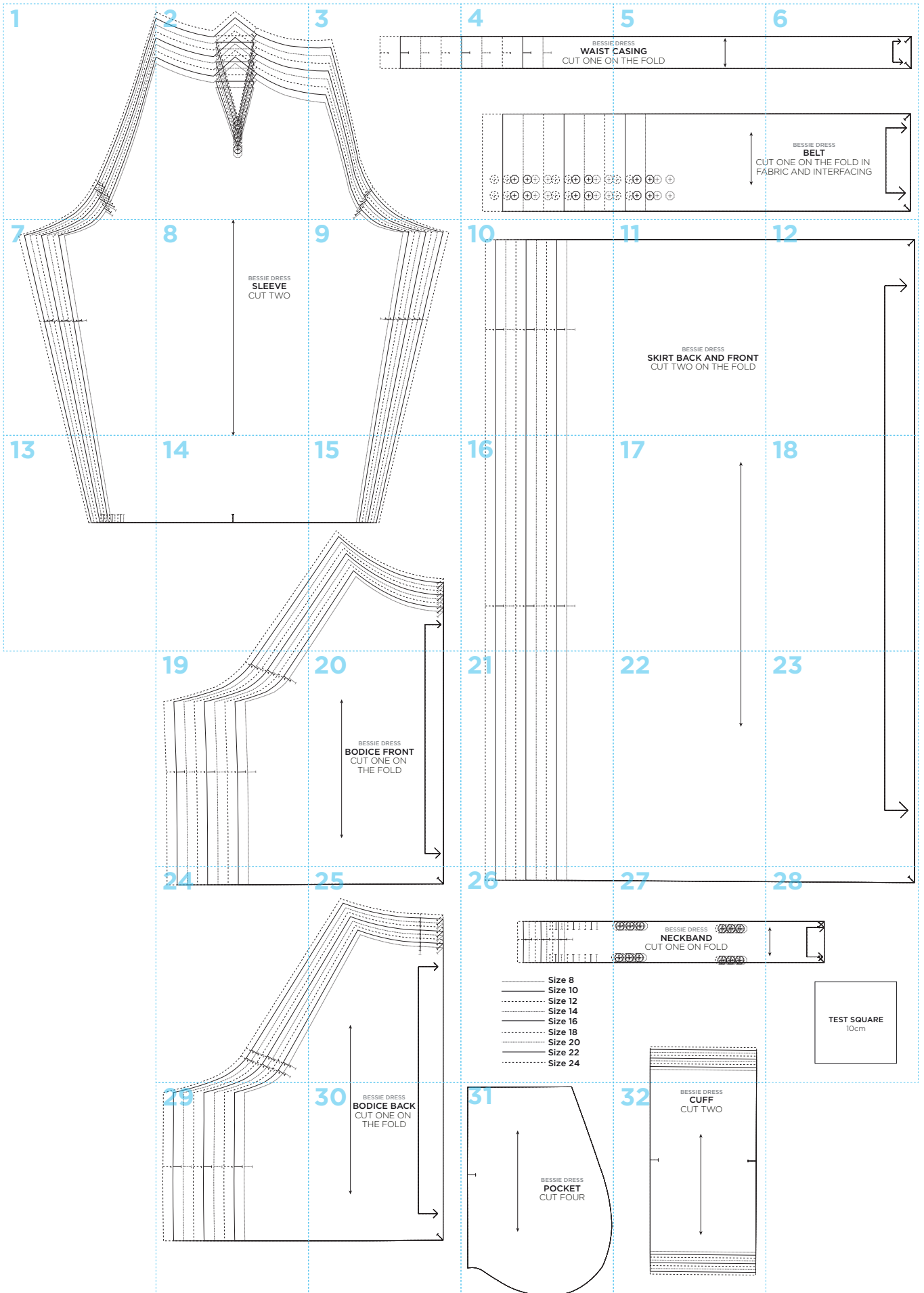

1

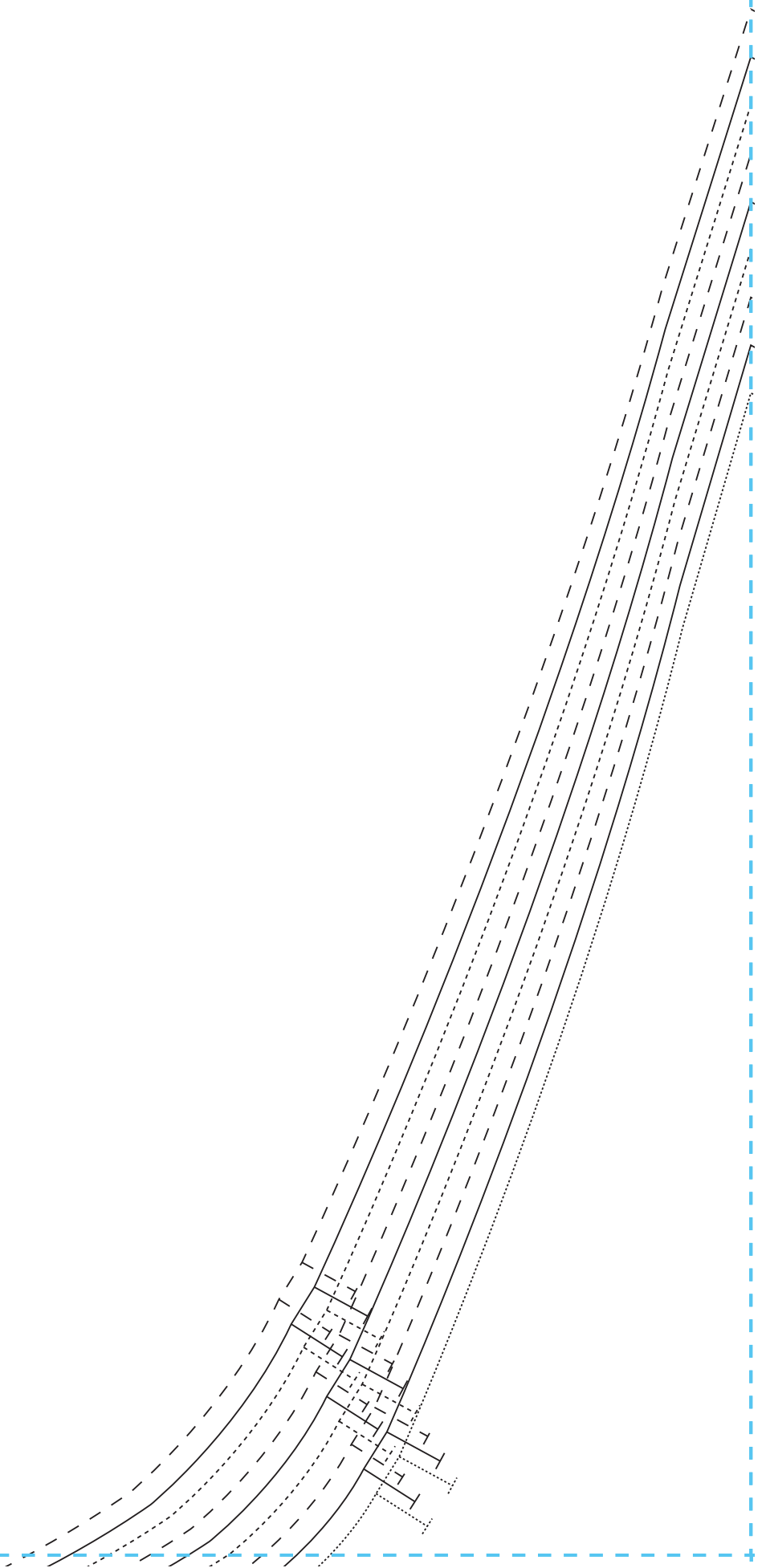

2

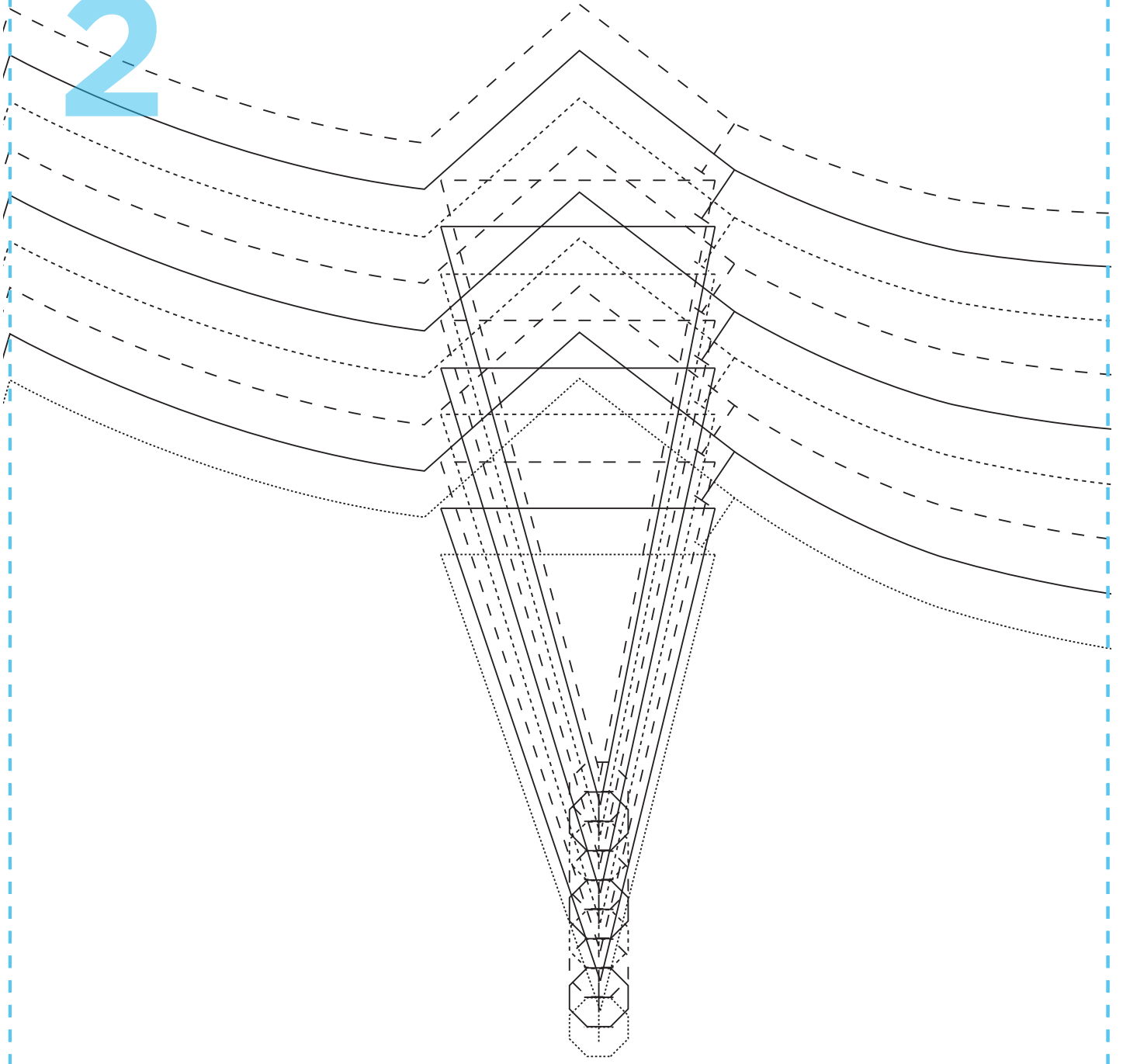

# 3

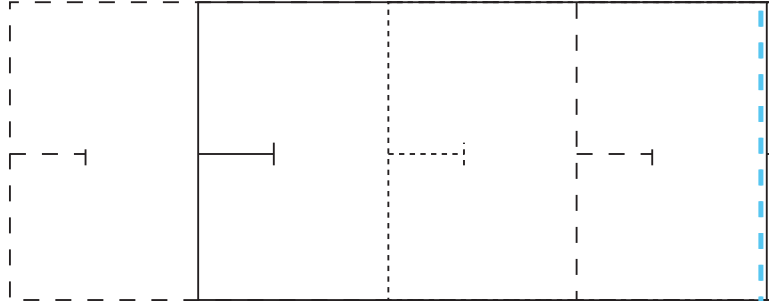
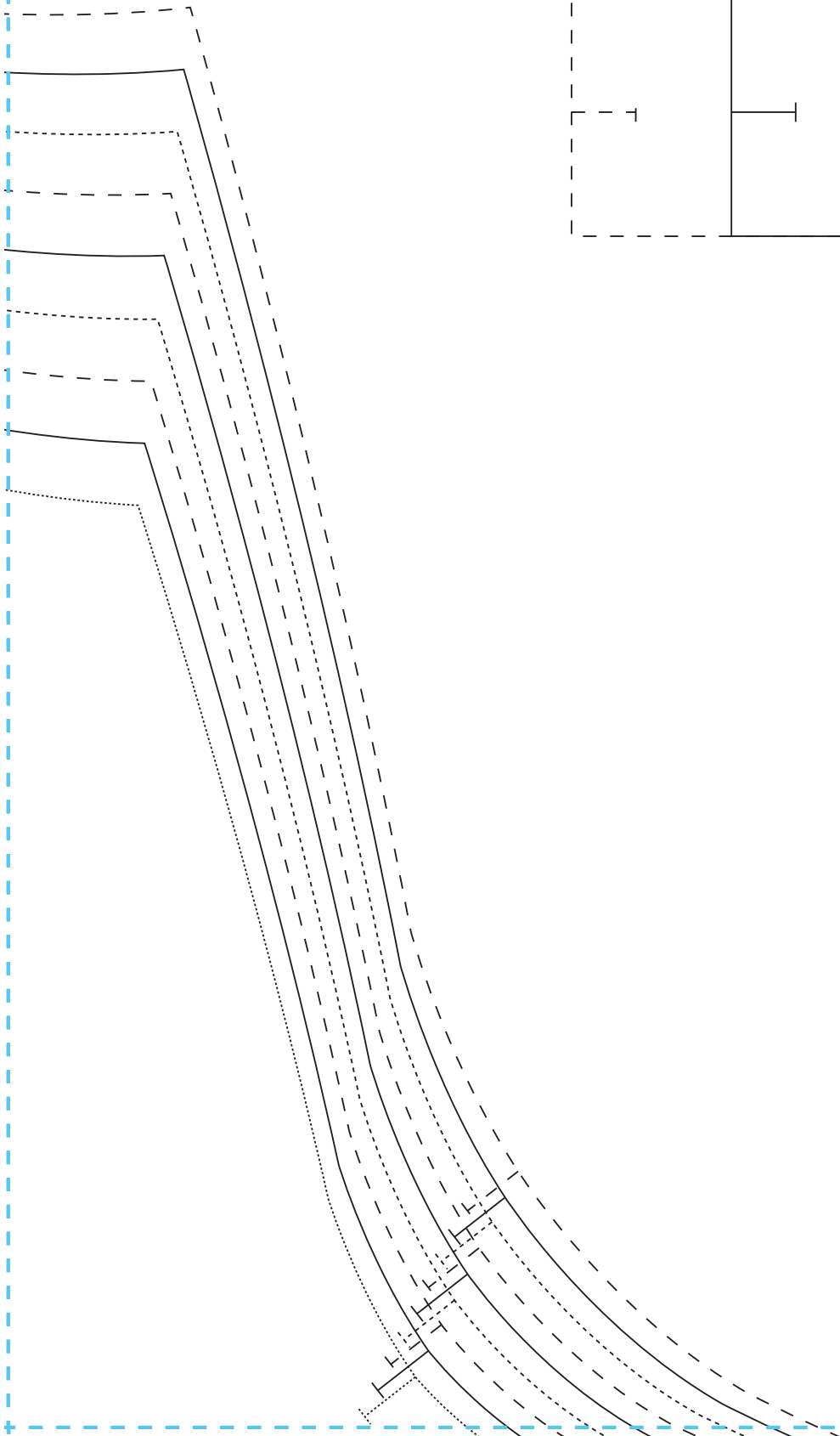

# 4

BESSIE  
**WAIST C**  
CUT ONE OF

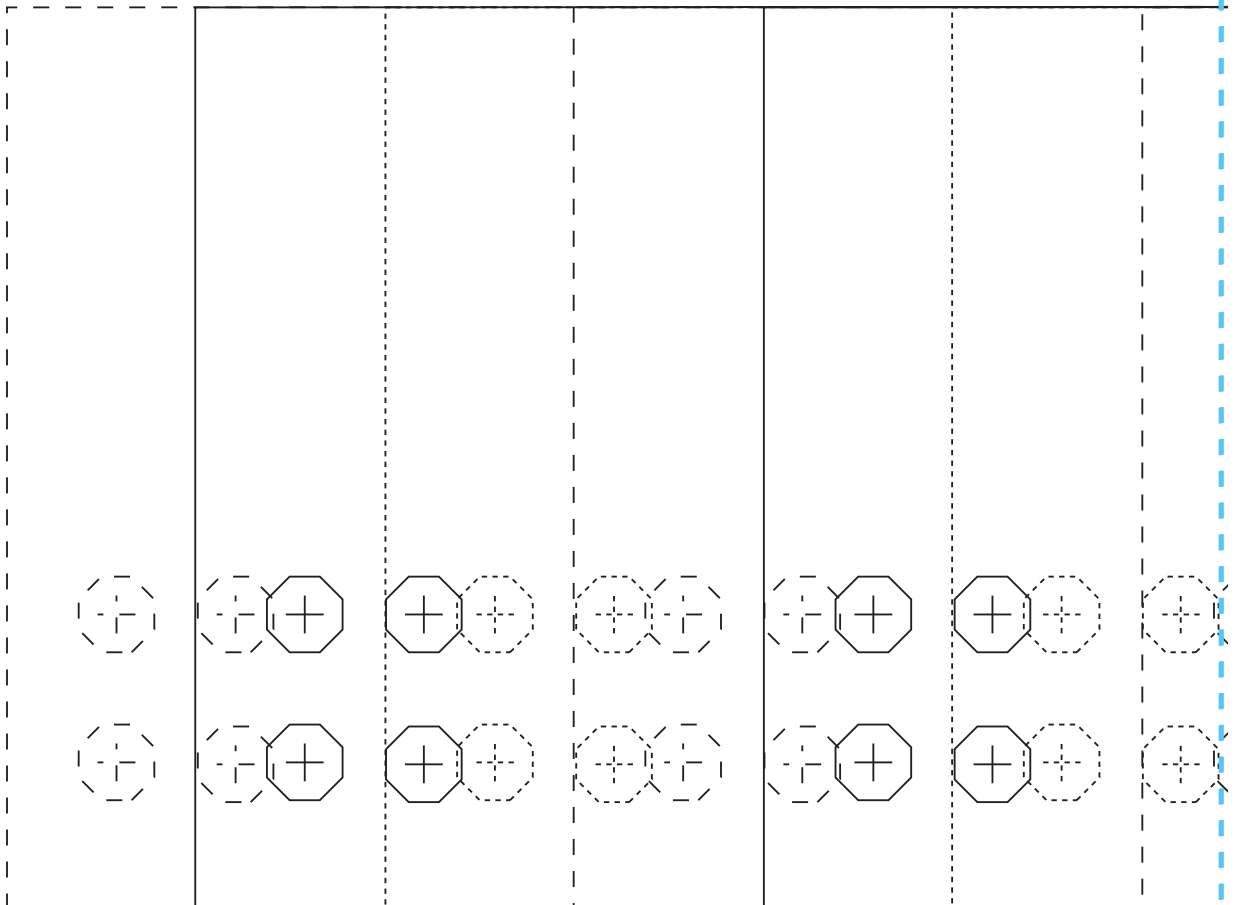

# 5

## DRESS CASING IN THE FOLD



CU  
FA

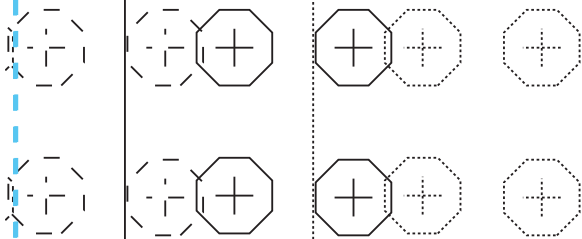

6

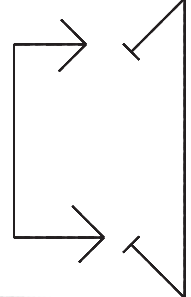

BESSIE DRESS  
**BELT**

CUT ONE ON THE FOLD IN  
FABRIC AND INTERFACING

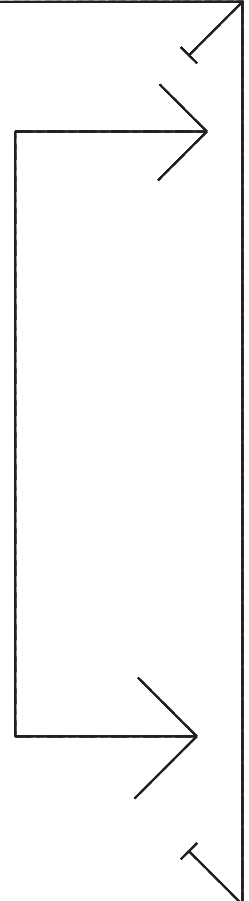



7

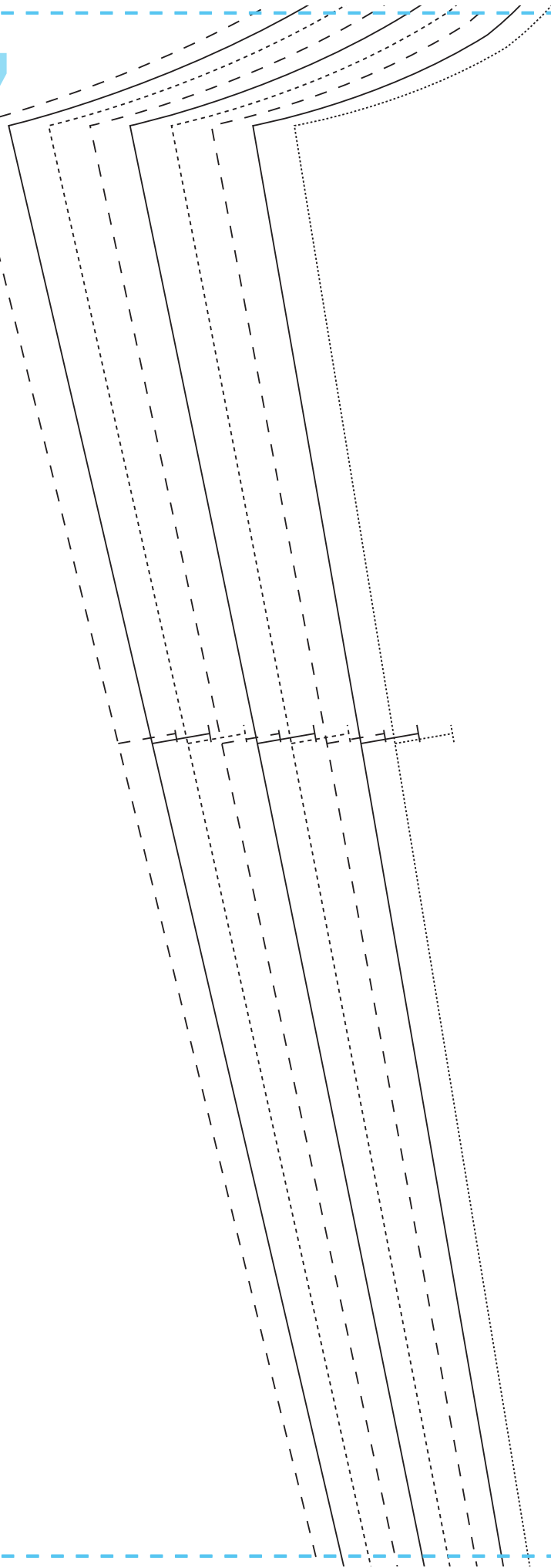

8

BESSIE DRESS  
**SLEEVE**  
CUT TWO

9

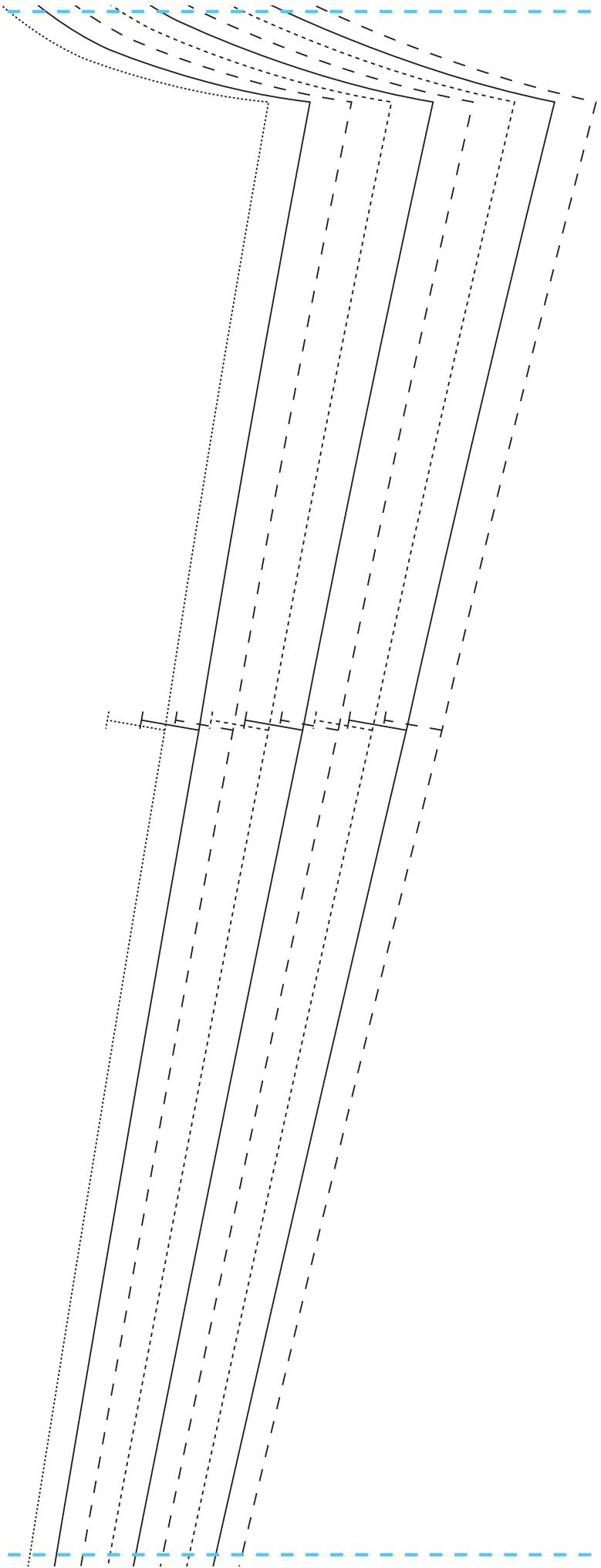

# 10

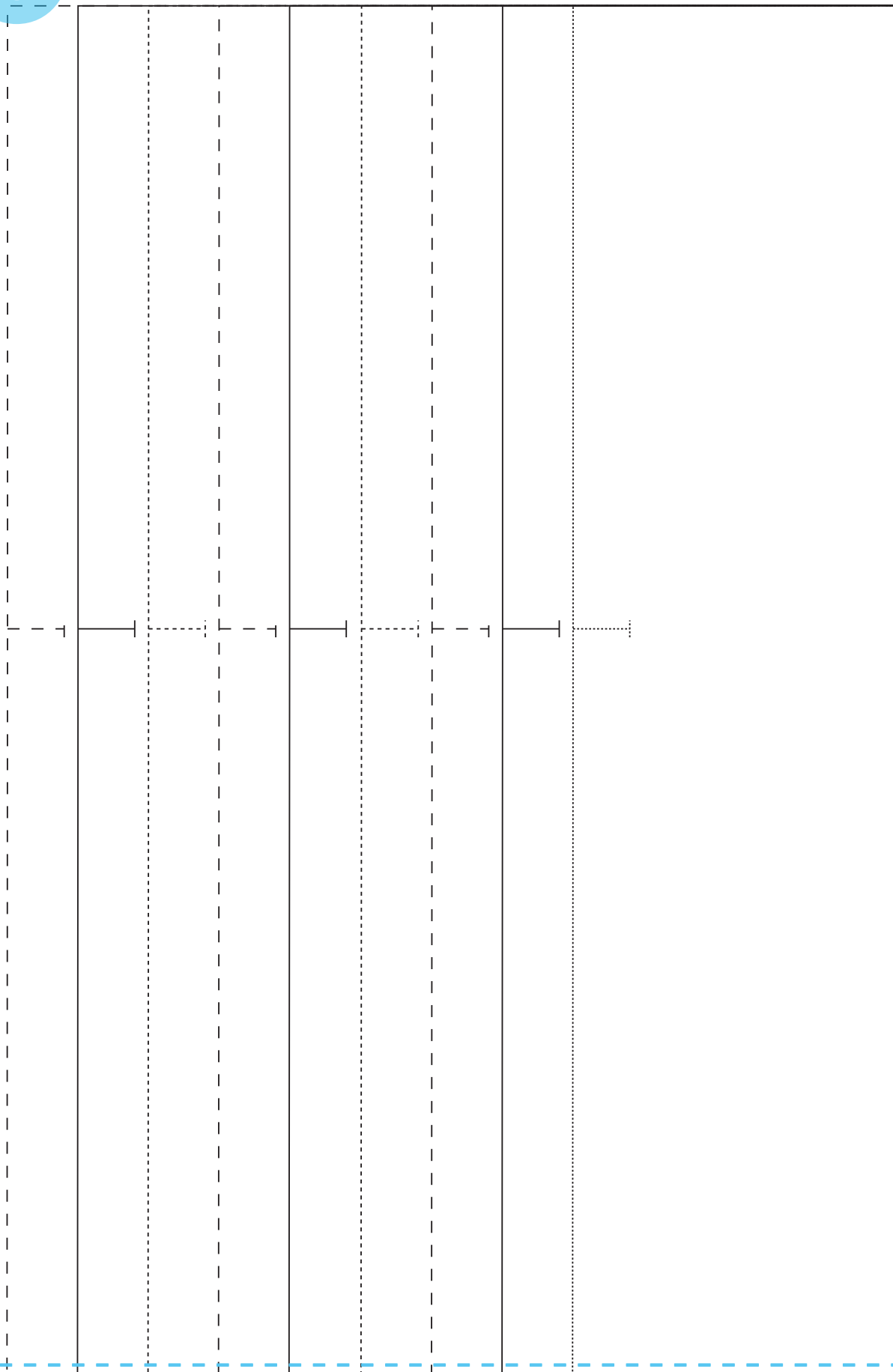

11

---

BESSIE DRESS  
**SKIRT BACK AND FRONT**  
CUT TWO ON THE FOLD

12

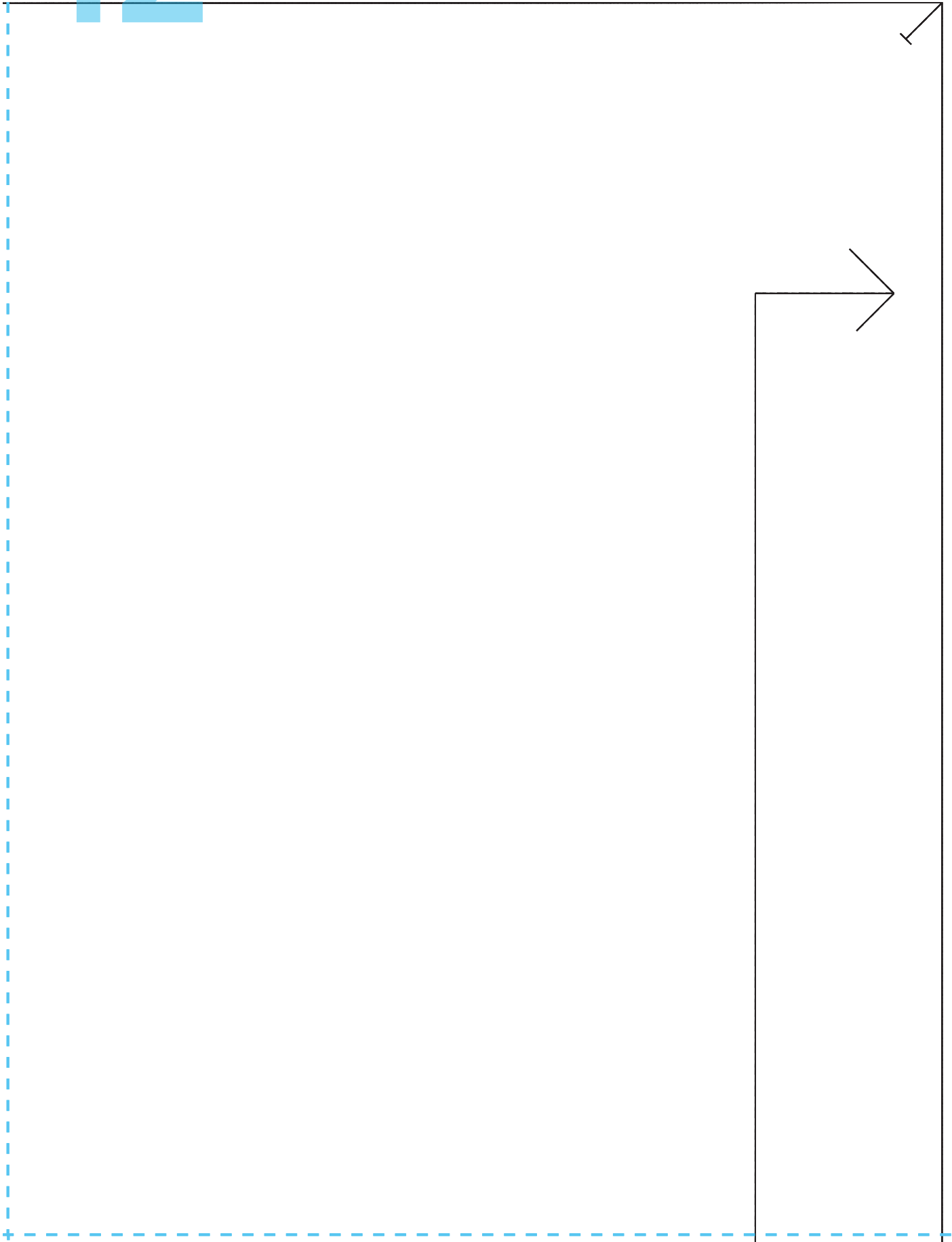

13

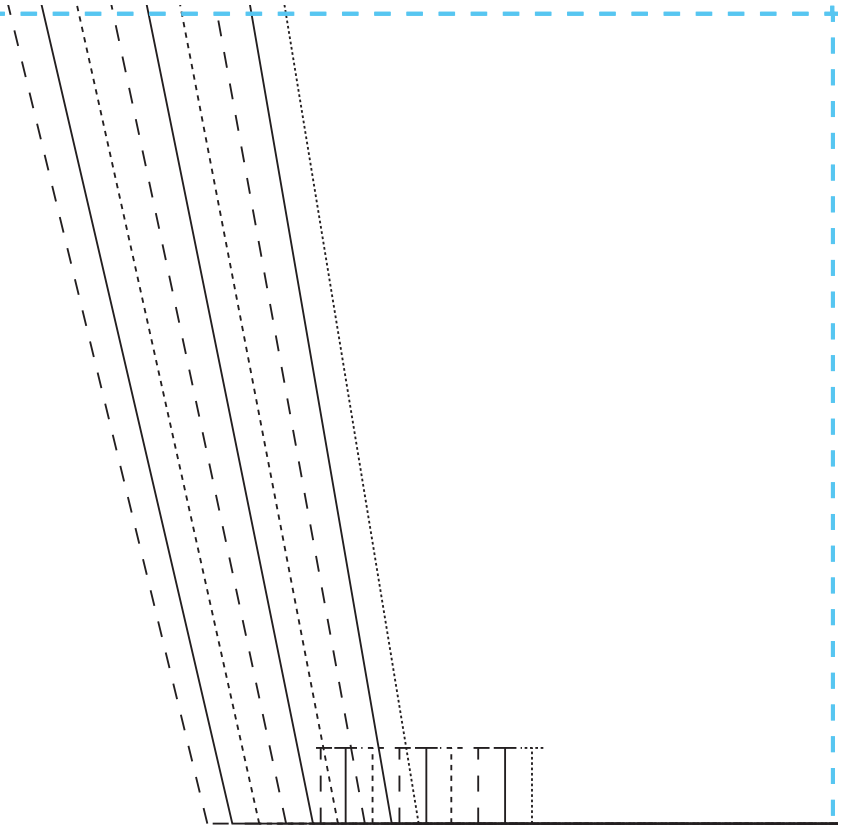

14

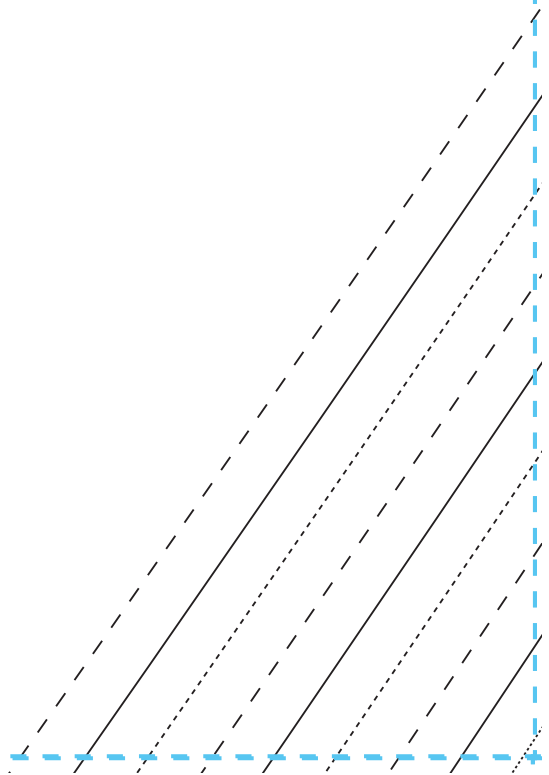



15

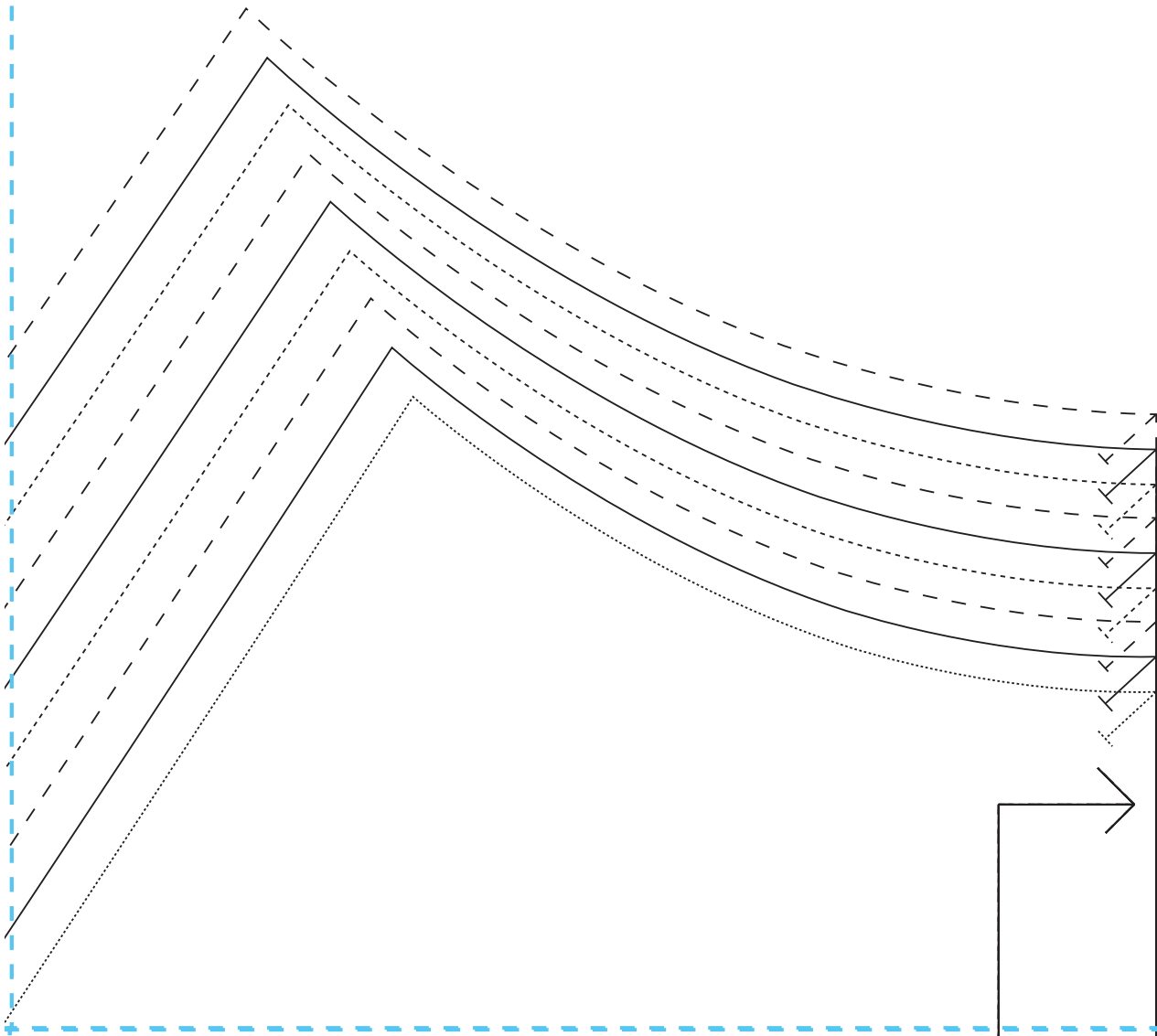
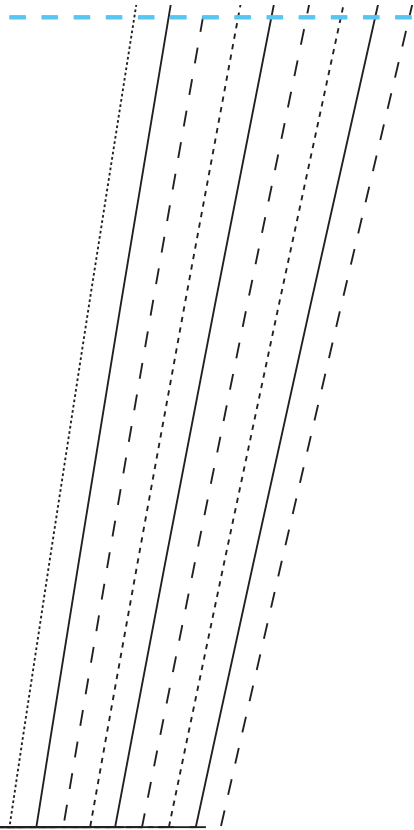

16

17



18

# 19

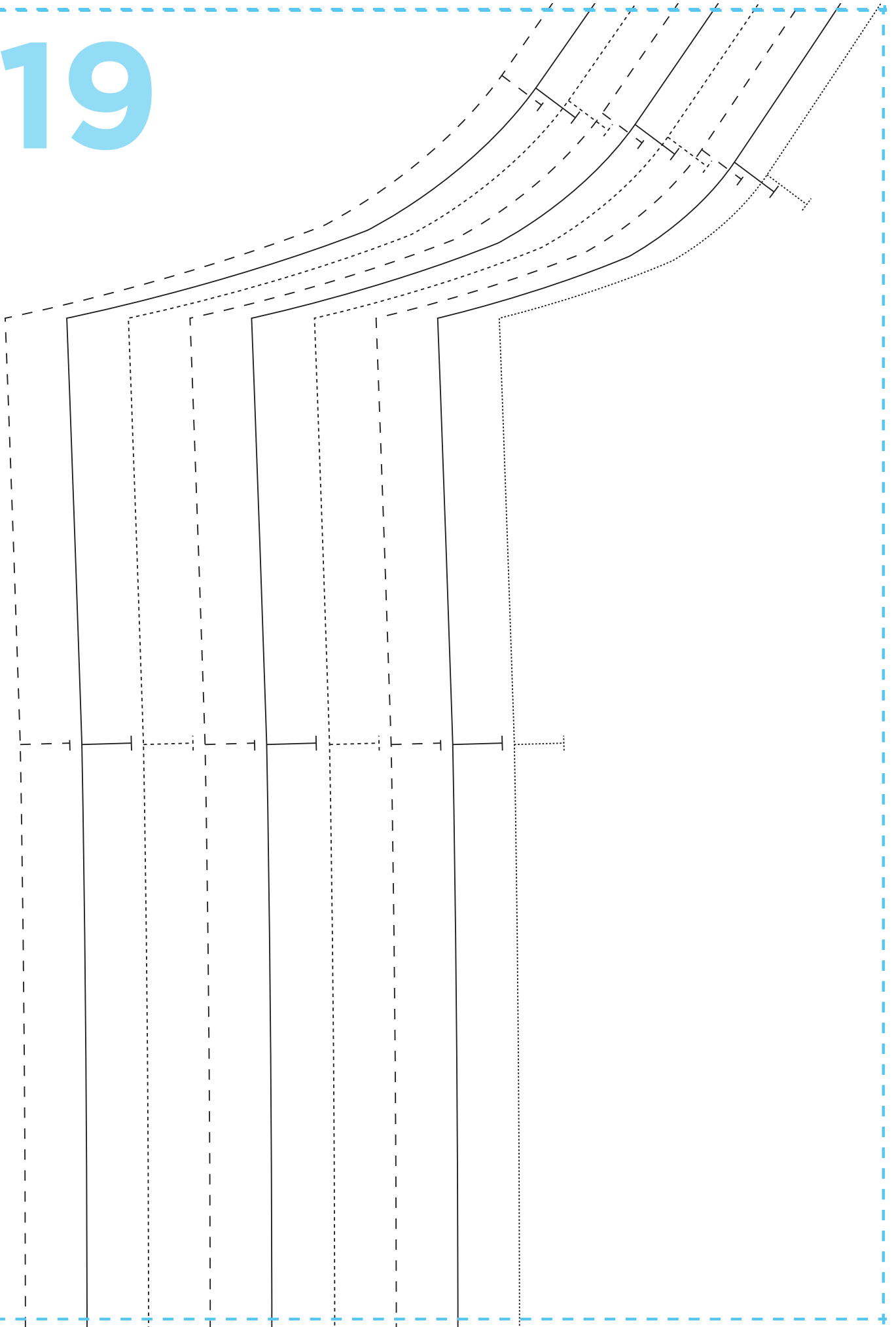

20



BESSIE DRESS  
**BODICE FRONT**  
CUT ONE ON  
THE FOLD

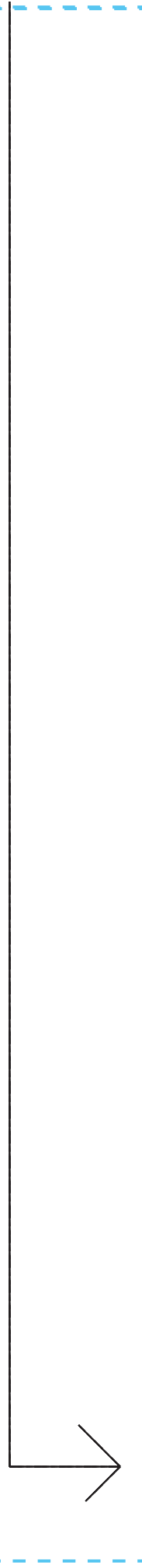

21

22





23



24

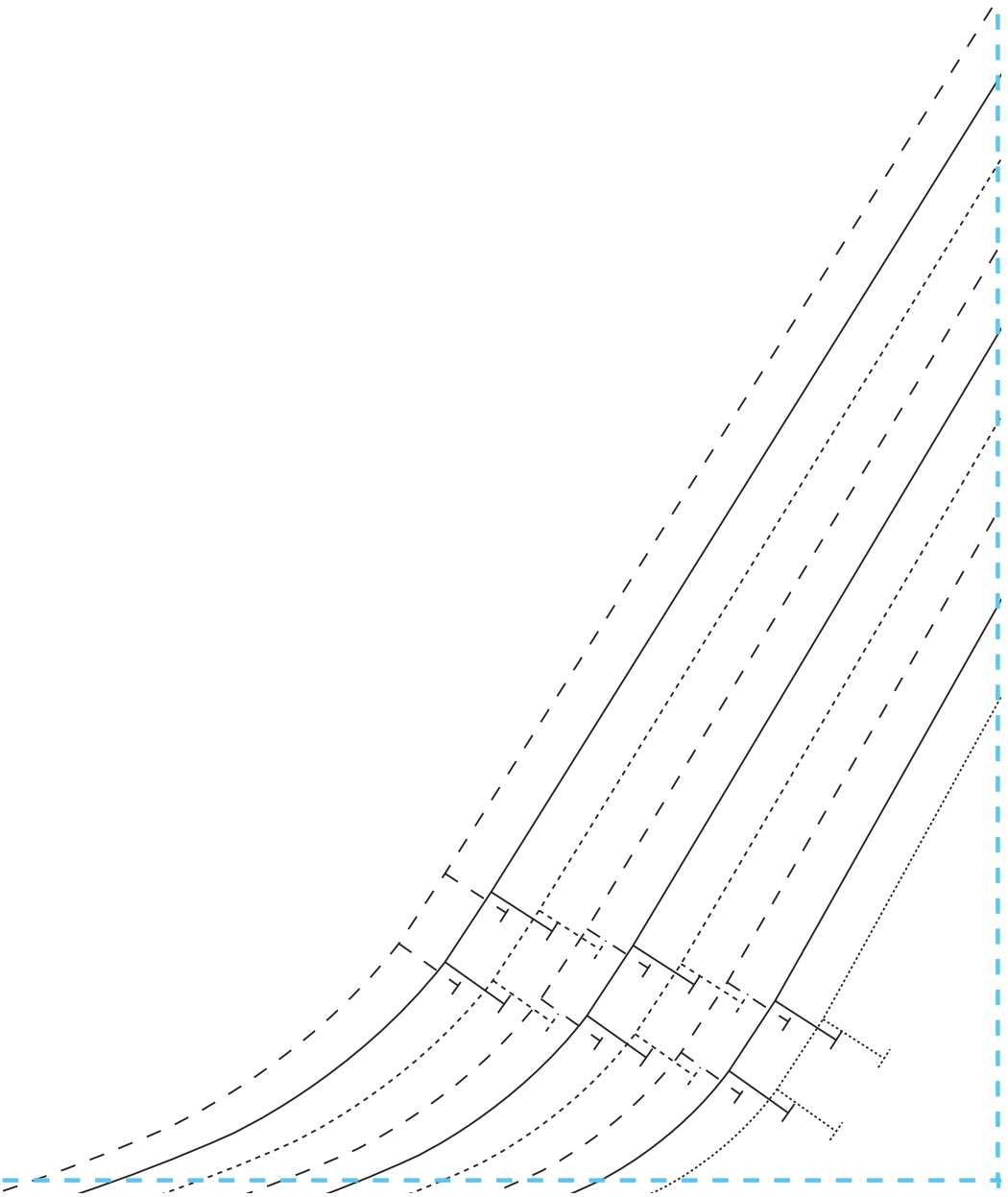

# 25

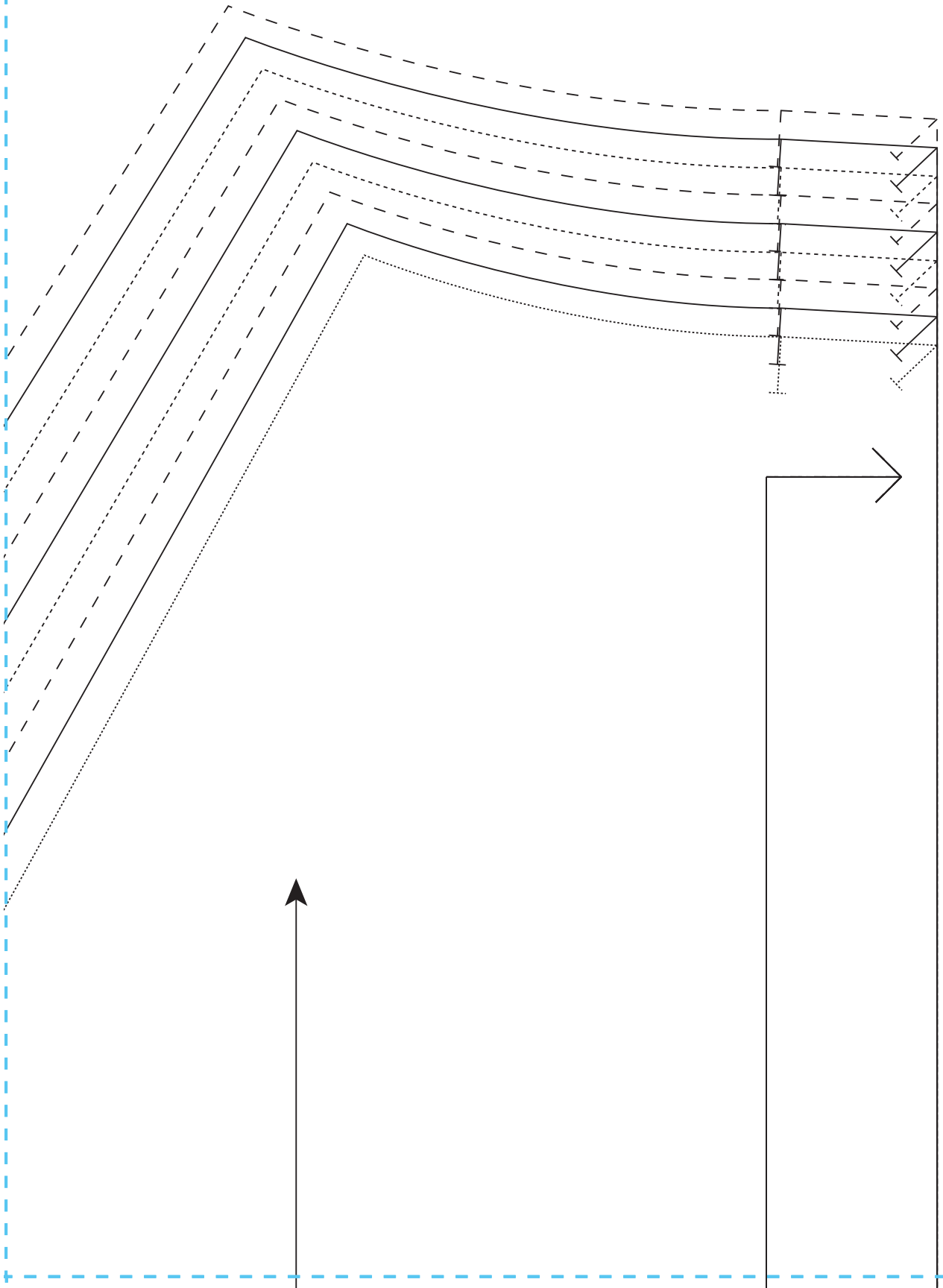

# 26

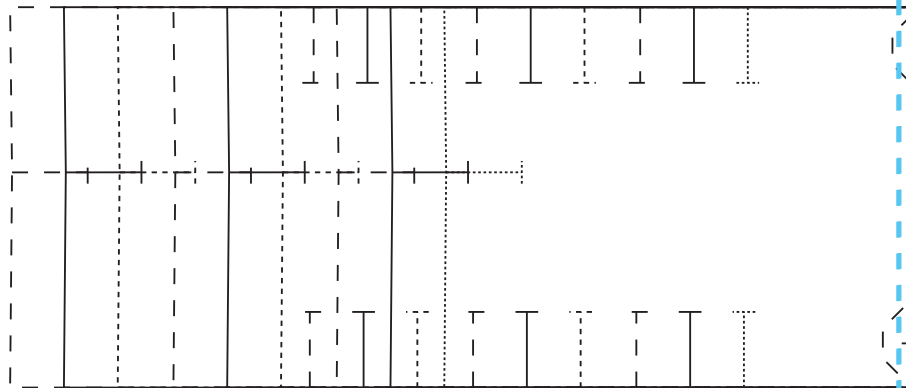

- ..... **Size 8**
- \_\_\_\_\_ **Size 10**
- - - - - **Size 12**
- ..... **Size 14**
- \_\_\_\_\_ **Size 16**
- - - - - **Size 18**
- ..... **Size 20**
- \_\_\_\_\_ **Size 22**
- - - - - **Size 24**

27

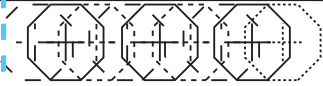

BESSIE DRESS



**NECKBAND**

CUT ONE ON FOLD

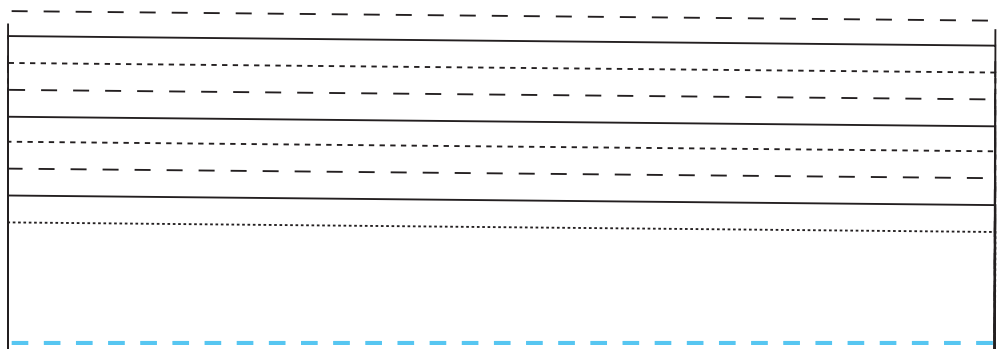
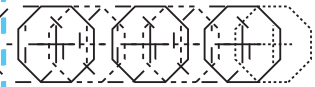

# 28

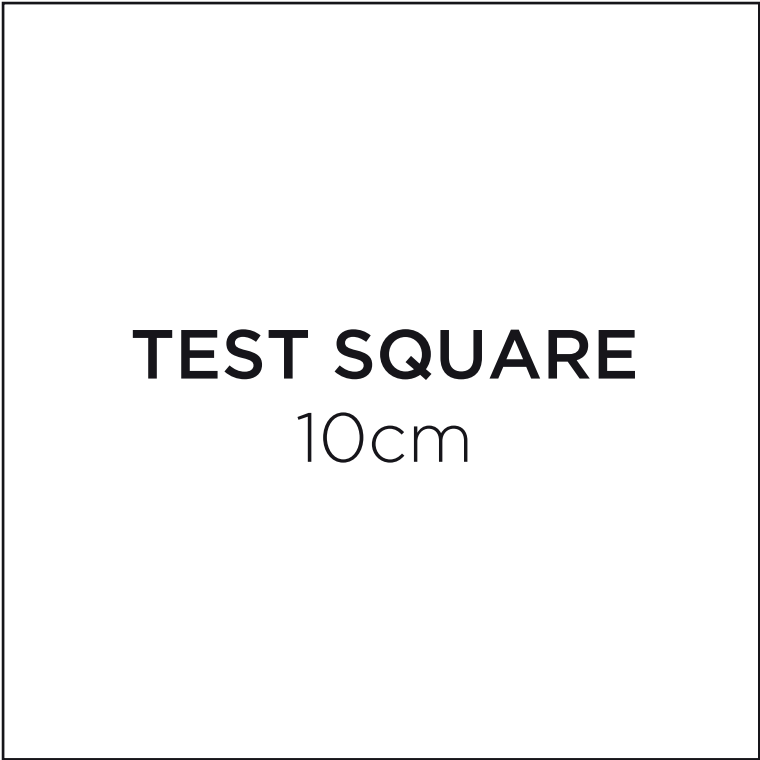
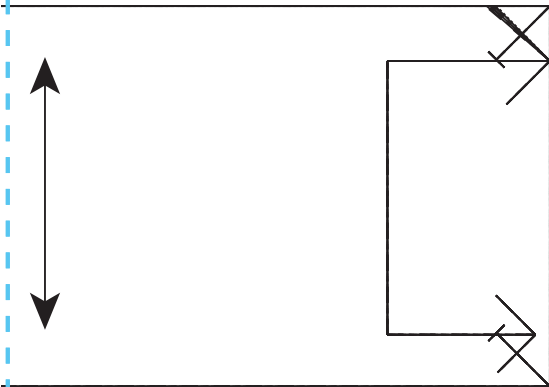

29

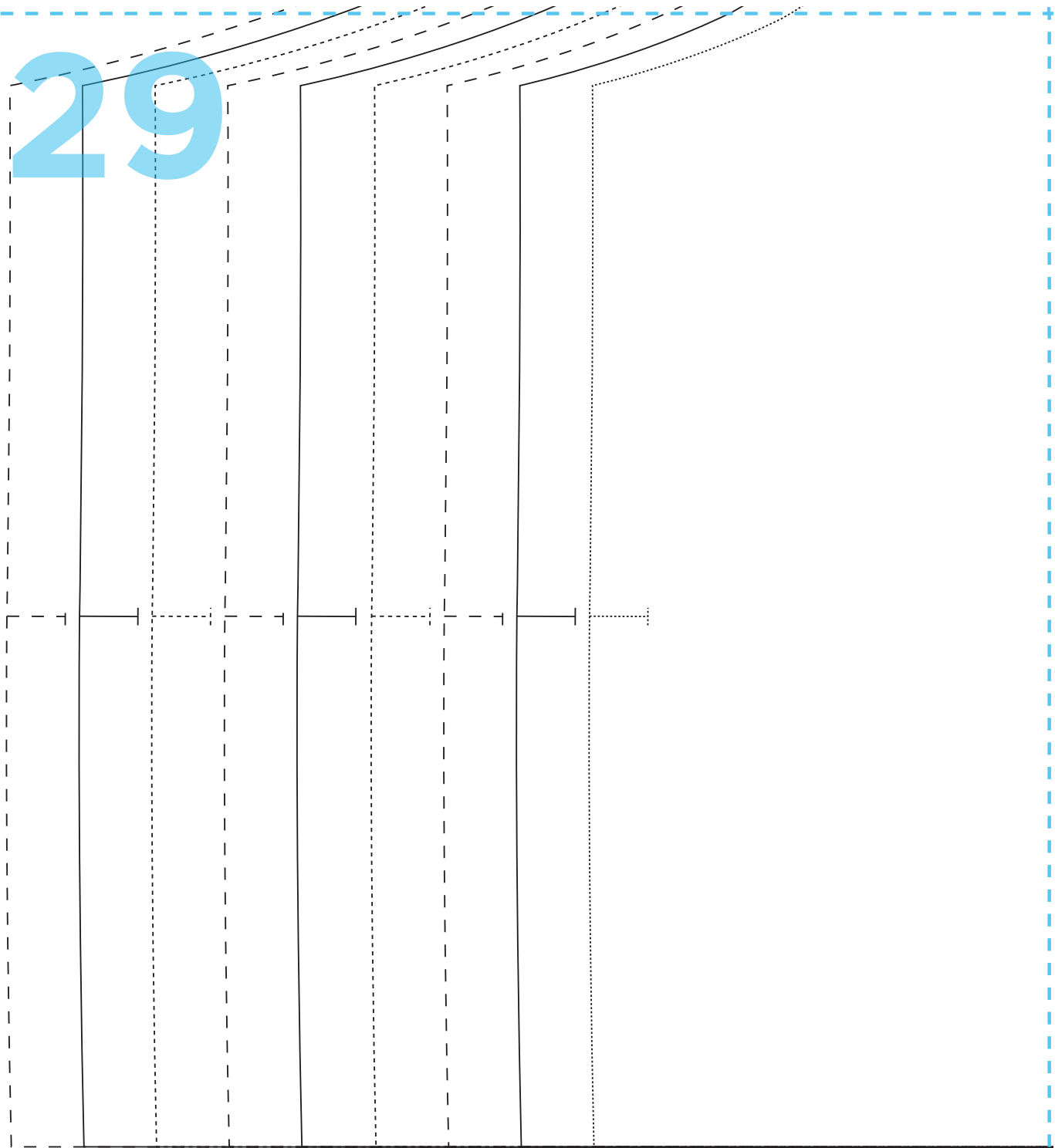

30

BESSIE DRESS  
**BODICE BACK**  
CUT ONE ON  
THE FOLD





31

BESSIE DRESS  
**POCKET**  
CUT FOUR



32

BESSIE DRESS  
**CUFF**  
CUT TWO

