

sew

Issue 128 October 2019

PRINT
OUT
& KEEP

AMELIE TOP PATTERN

Use these guides to get started today

IN YOUR PRINT MENU, UNDER SIZE OPTIONS, BE SURE TO
SELECT '**ACTUAL SIZE**', INSTEAD OF 'FIT TO PAGE'

Title: Amelie Top
Designer: Amanda Walker
Magazine page: 26



© ACEVILLE PUBLICATIONS LTD | SEWMAG.CO.UK

All projects, templates and patterns are for personal home use only and cannot be sold or used for commercial purposes.

AMELIE TOP PATTERN LAYOUT

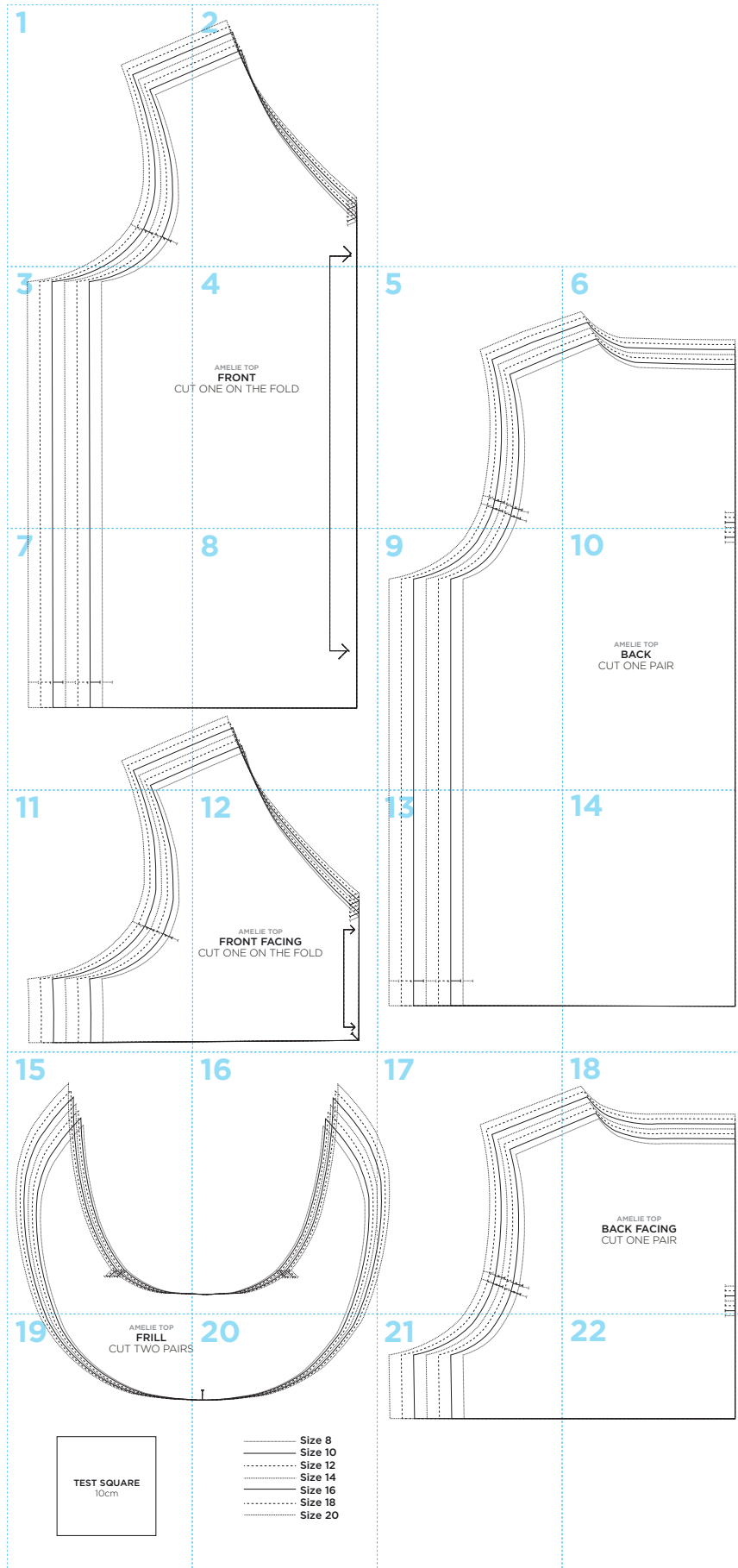

1

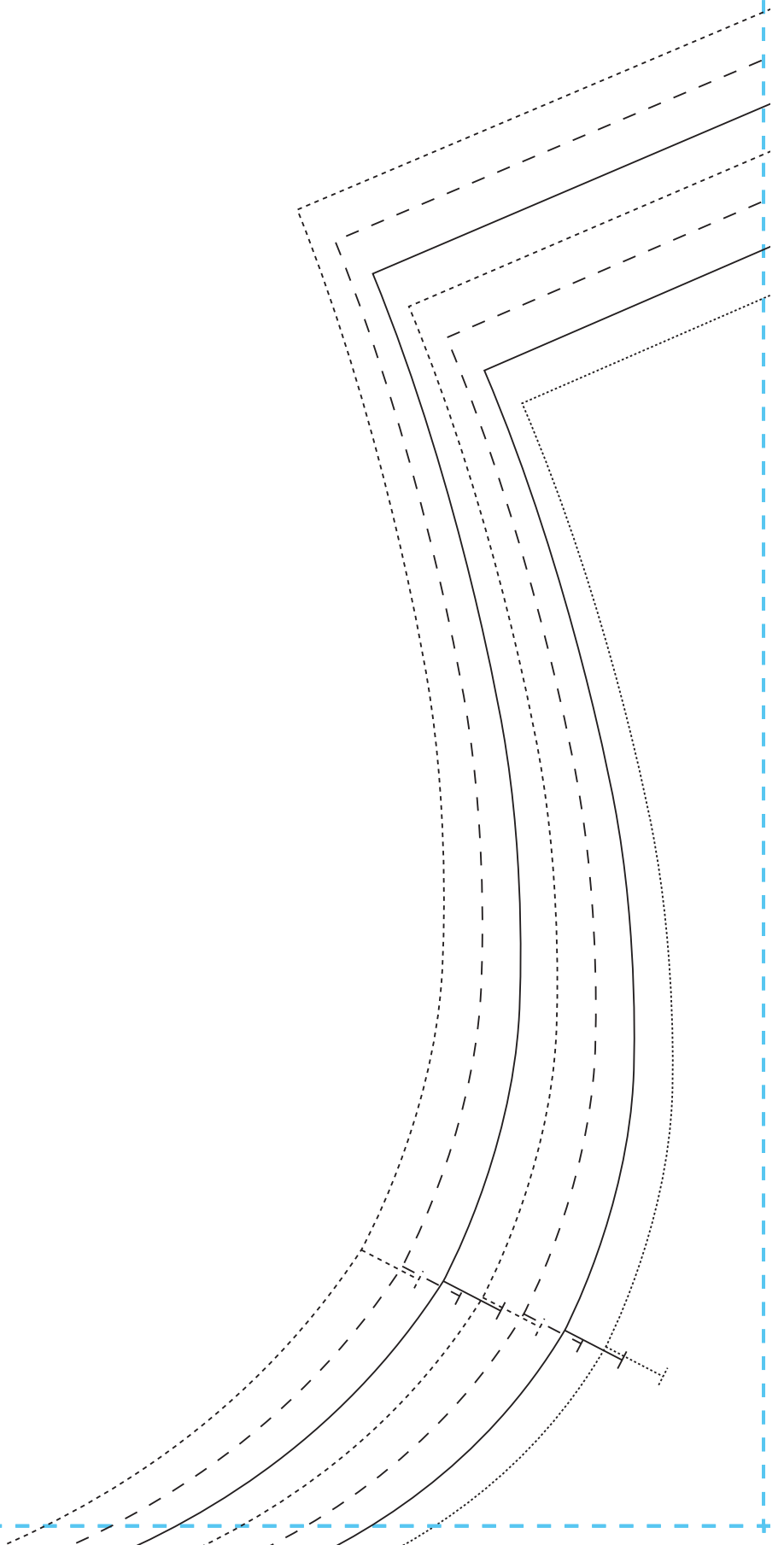

2

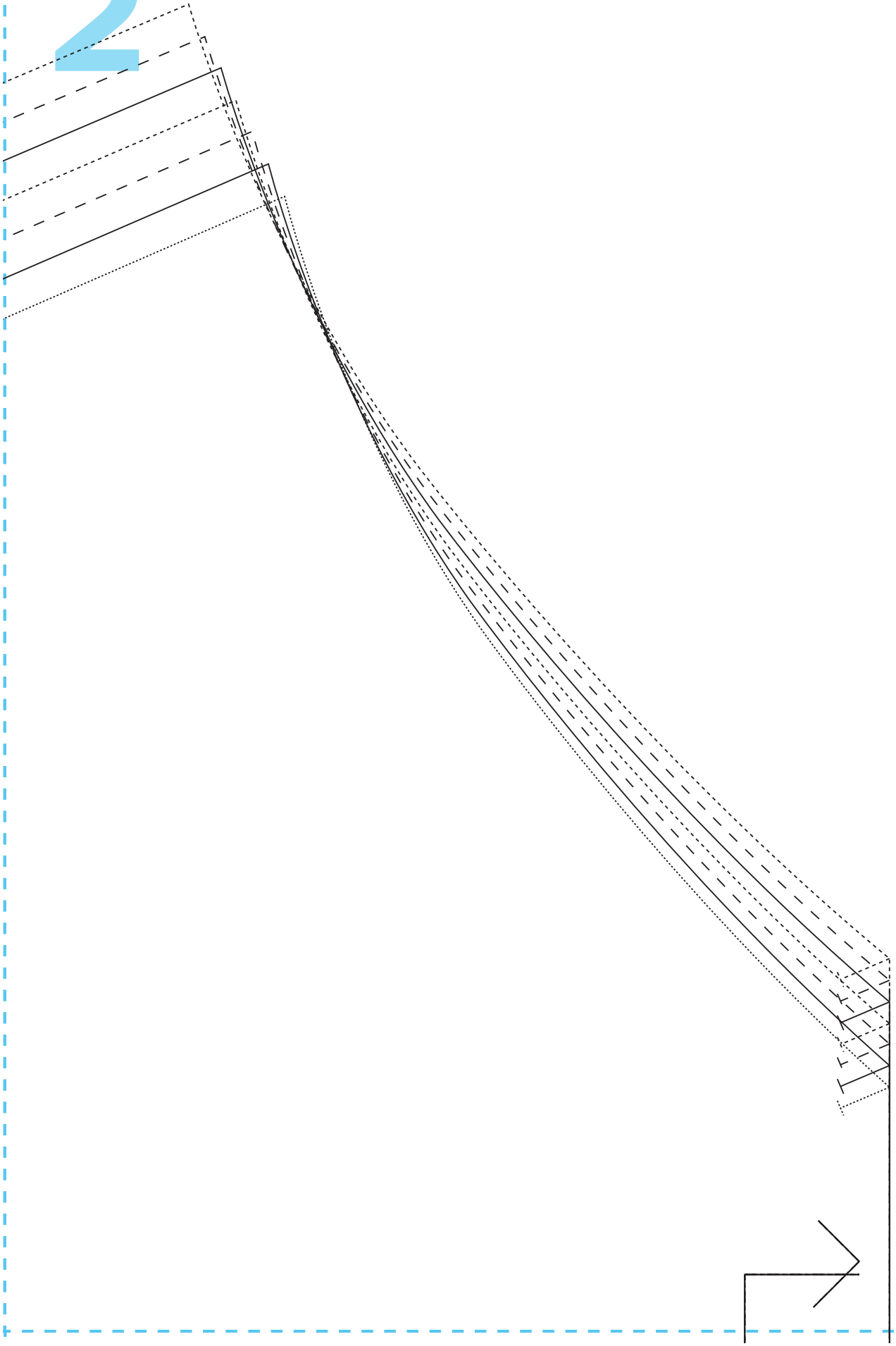

3

CUT

4

AMELIE TOP

FRONT

T ONE ON THE FOLD

5

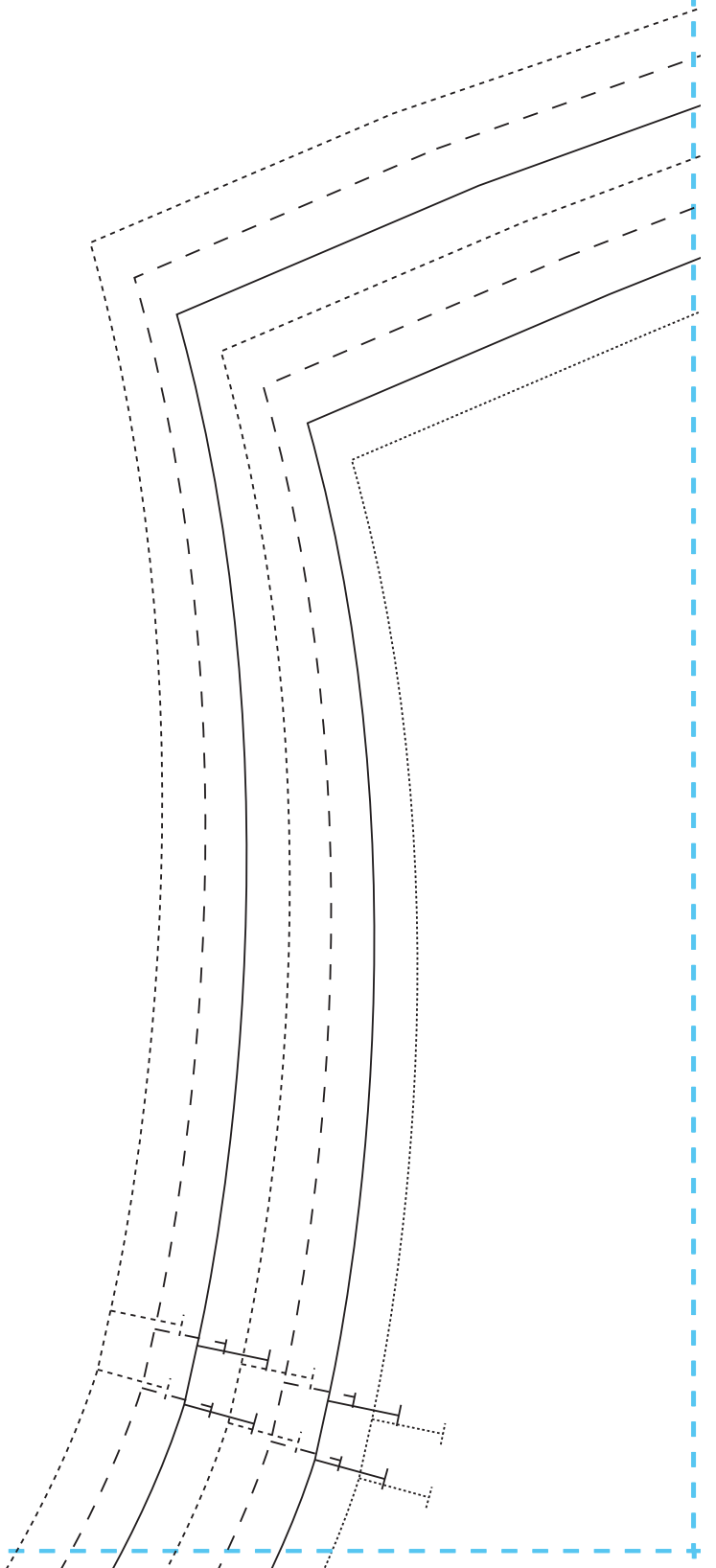

6

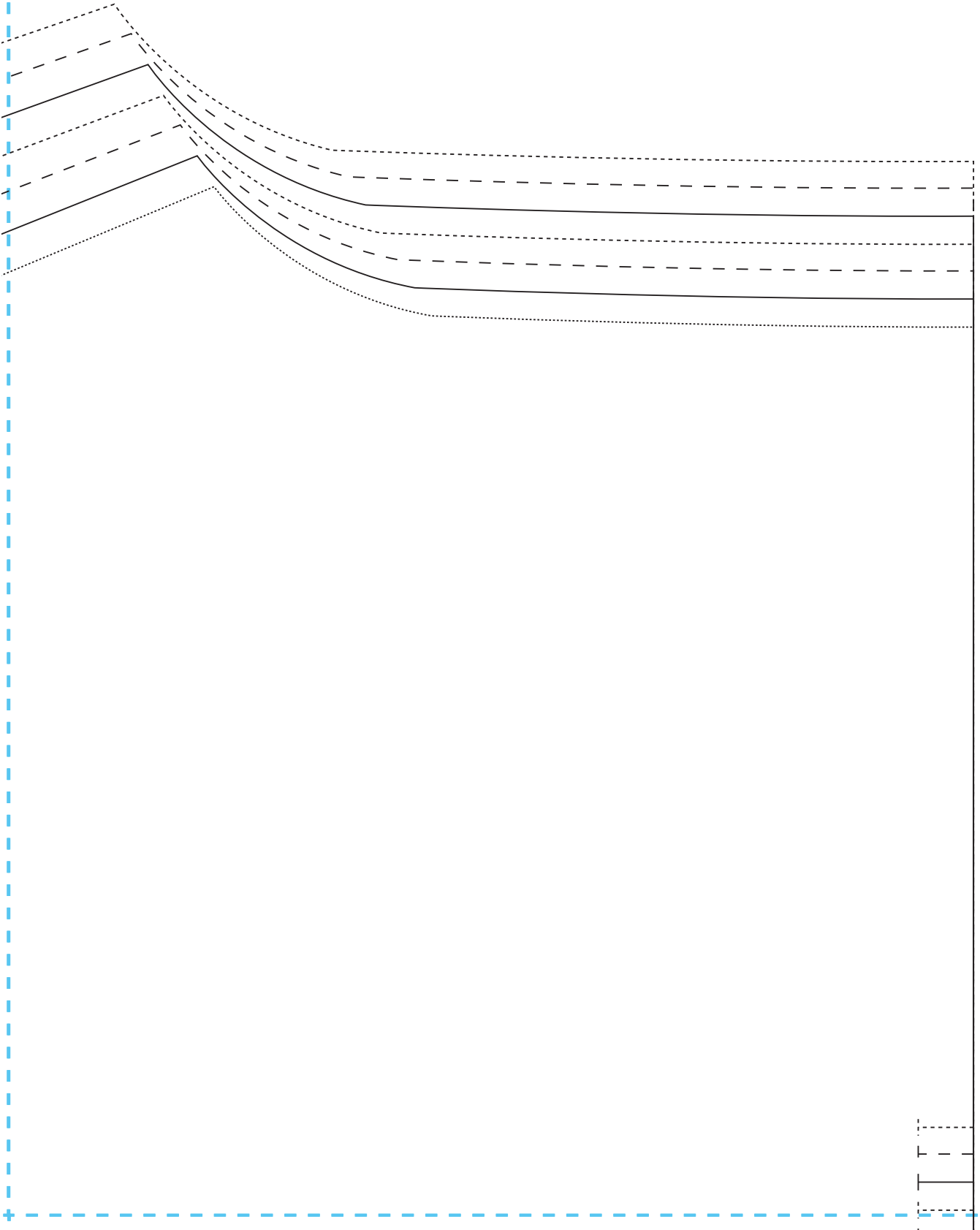

7

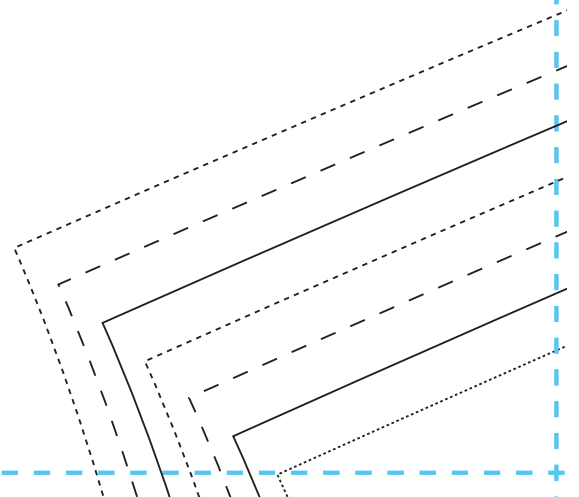
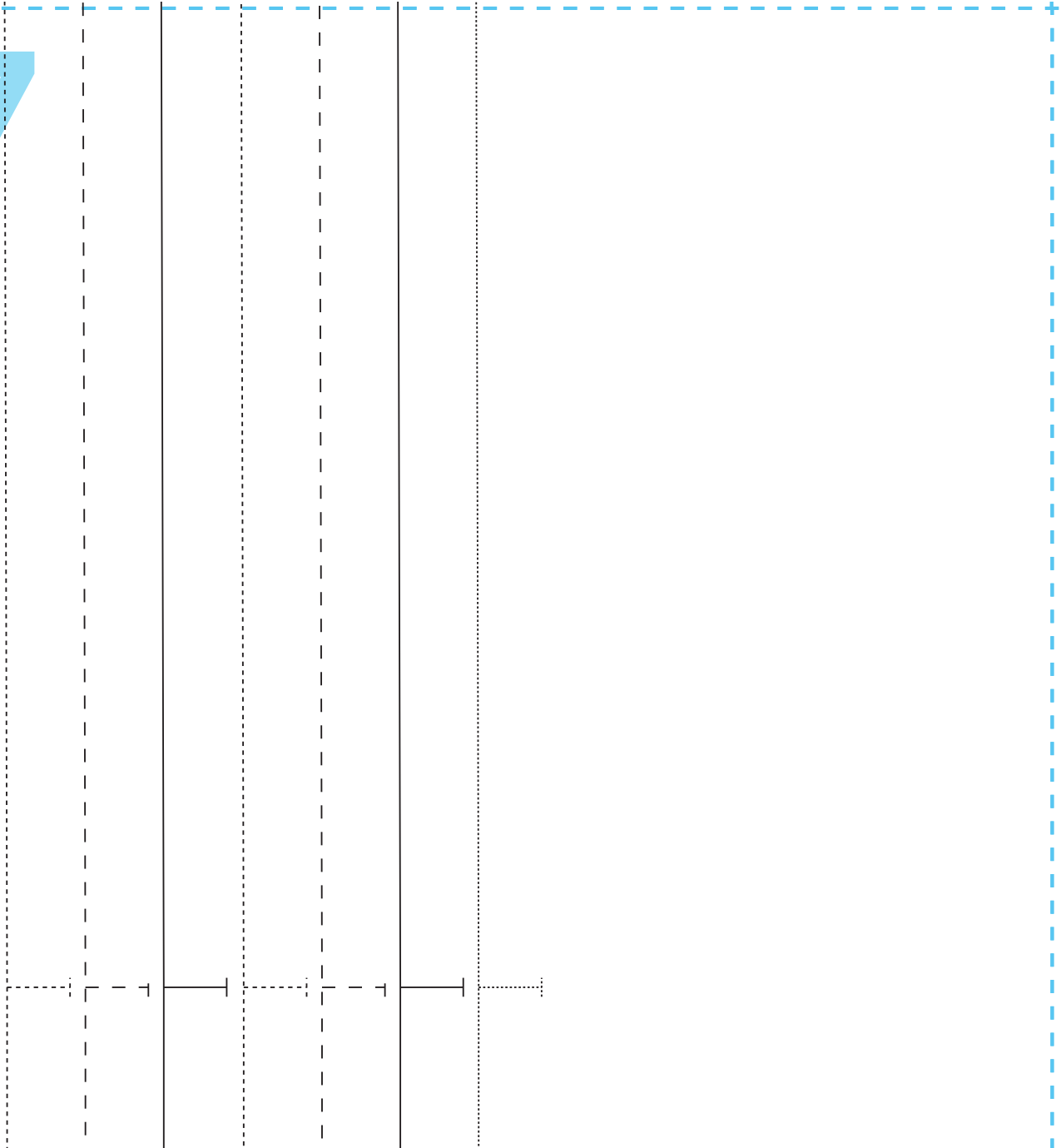

8

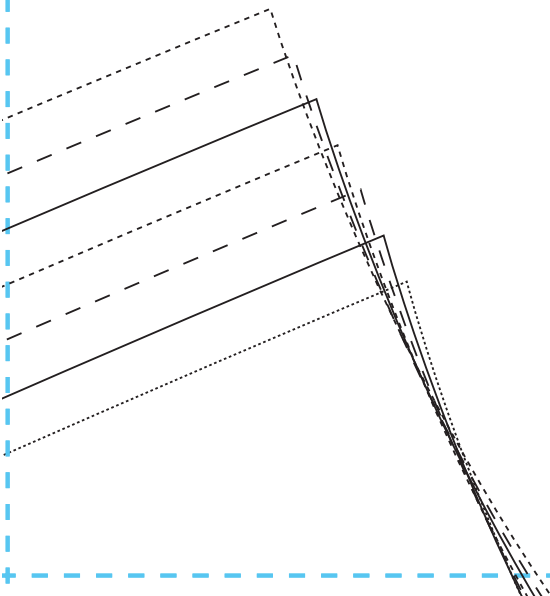
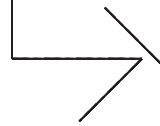

9

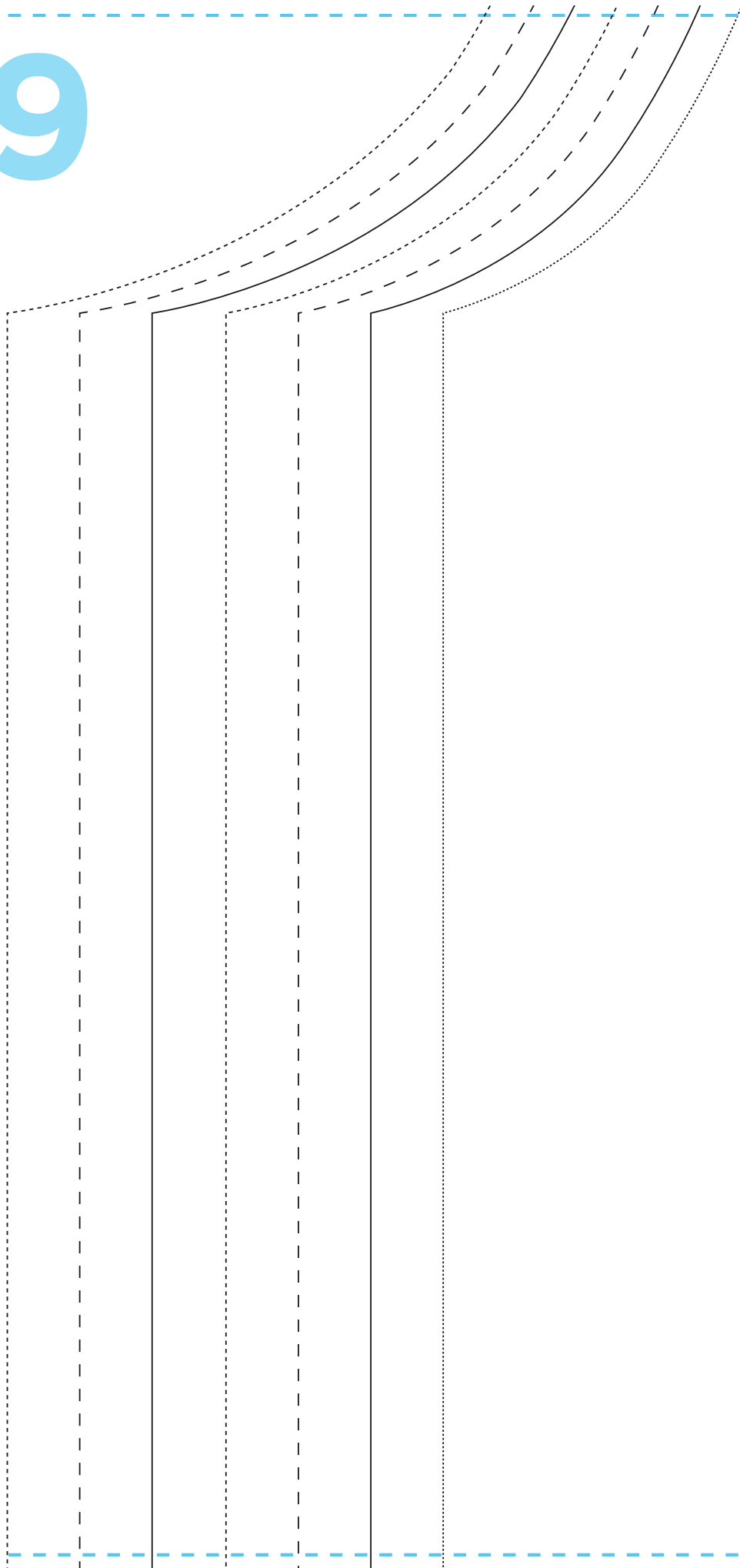

10

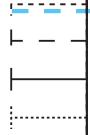

AMELIE TOP
BACK
CUT ONE PAIR

11

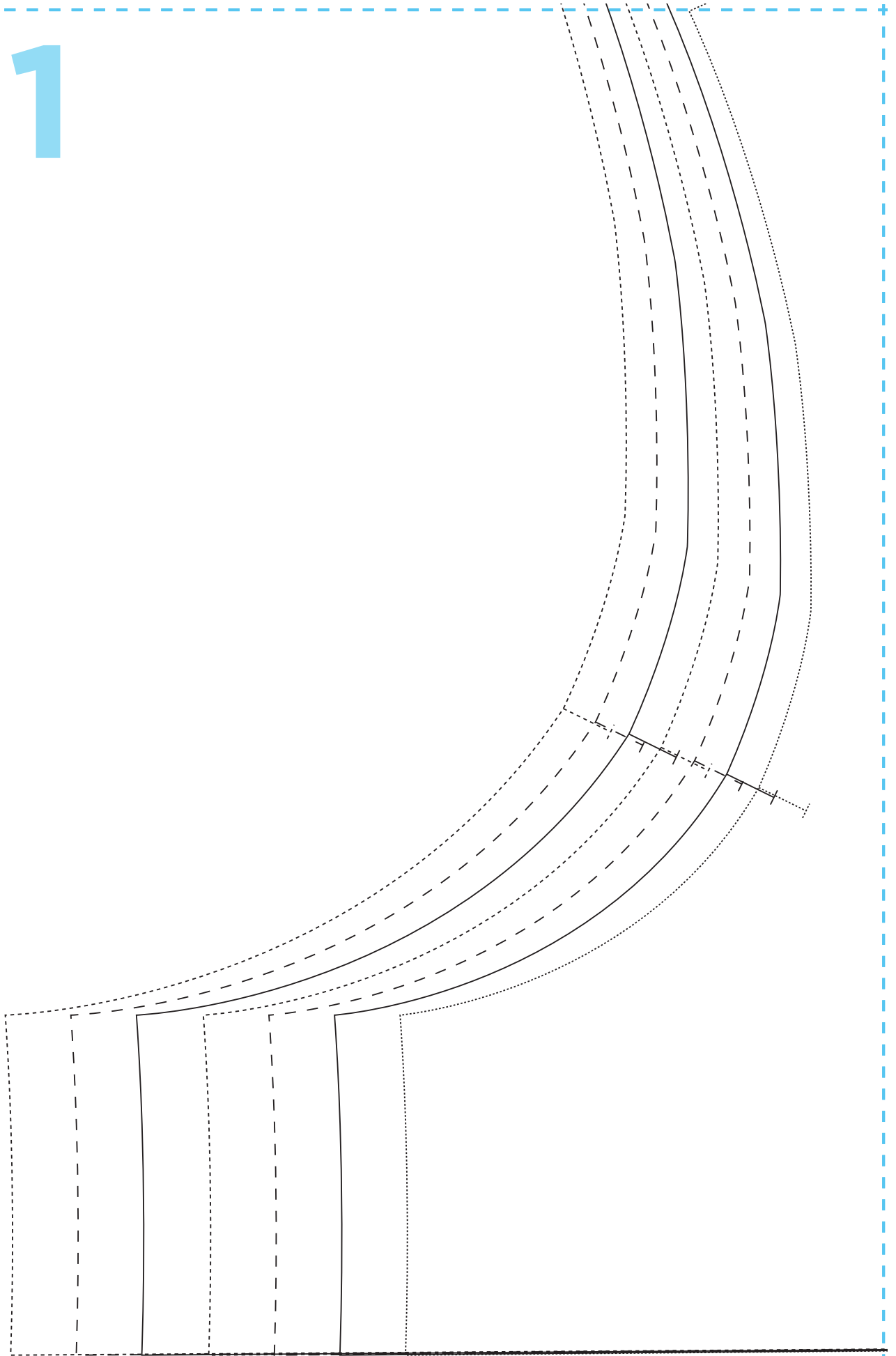

12

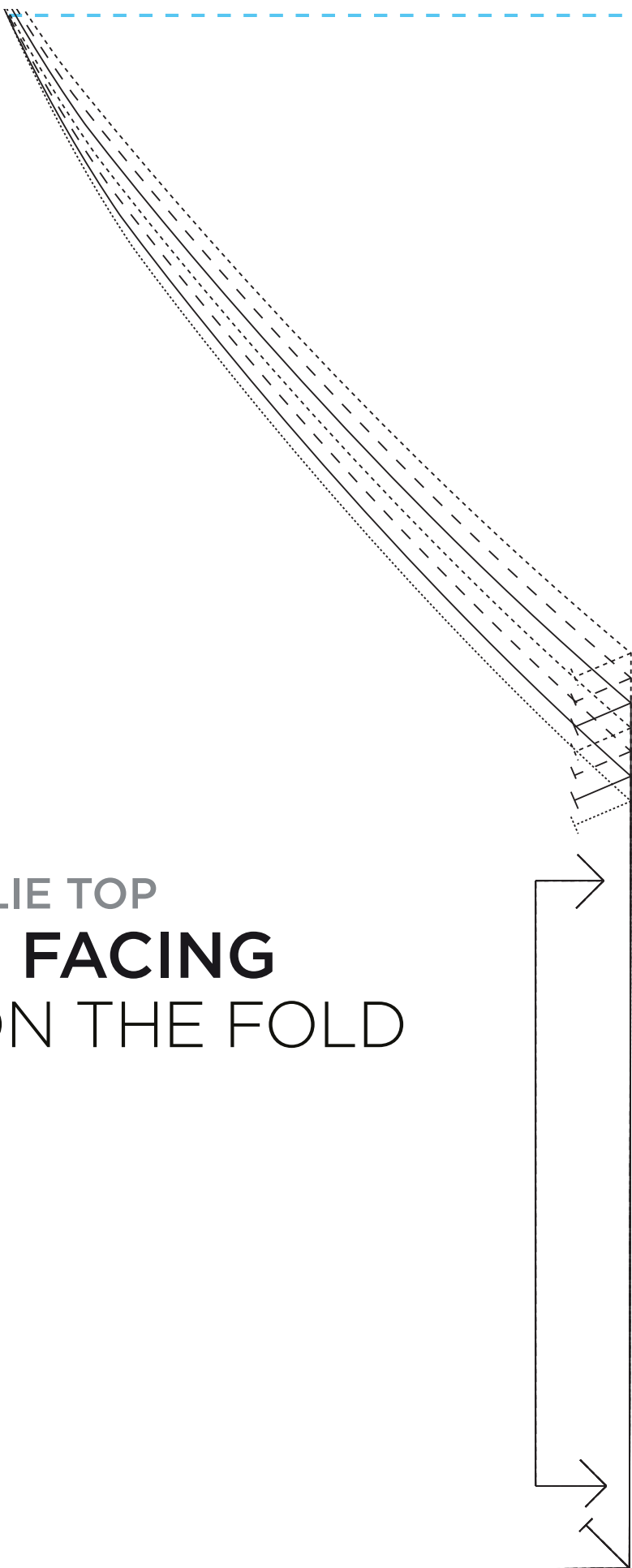

AMELIE TOP
FRONT FACING
CUT ONE ON THE FOLD

13

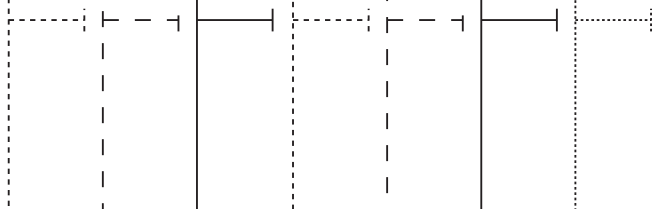

14

15

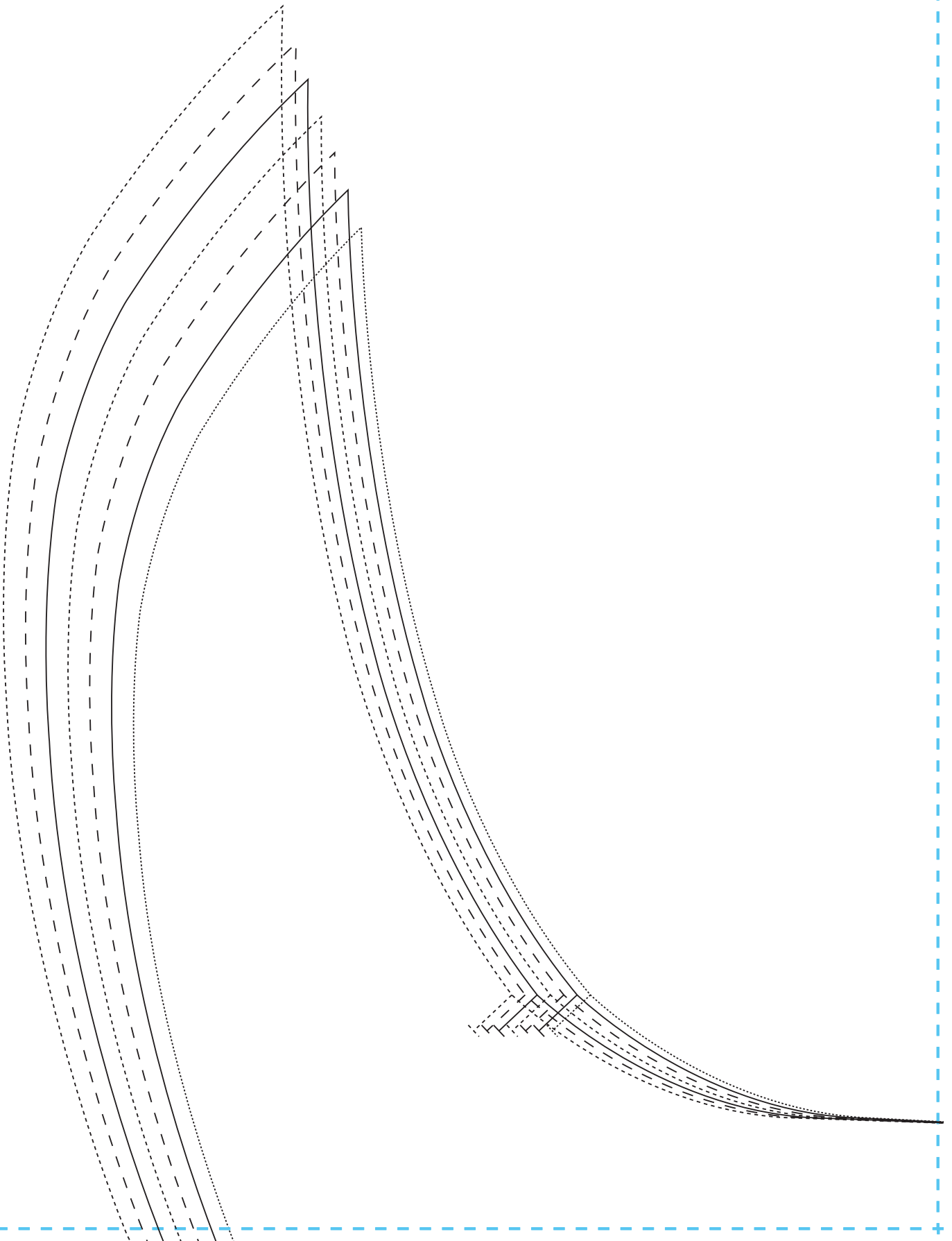

16

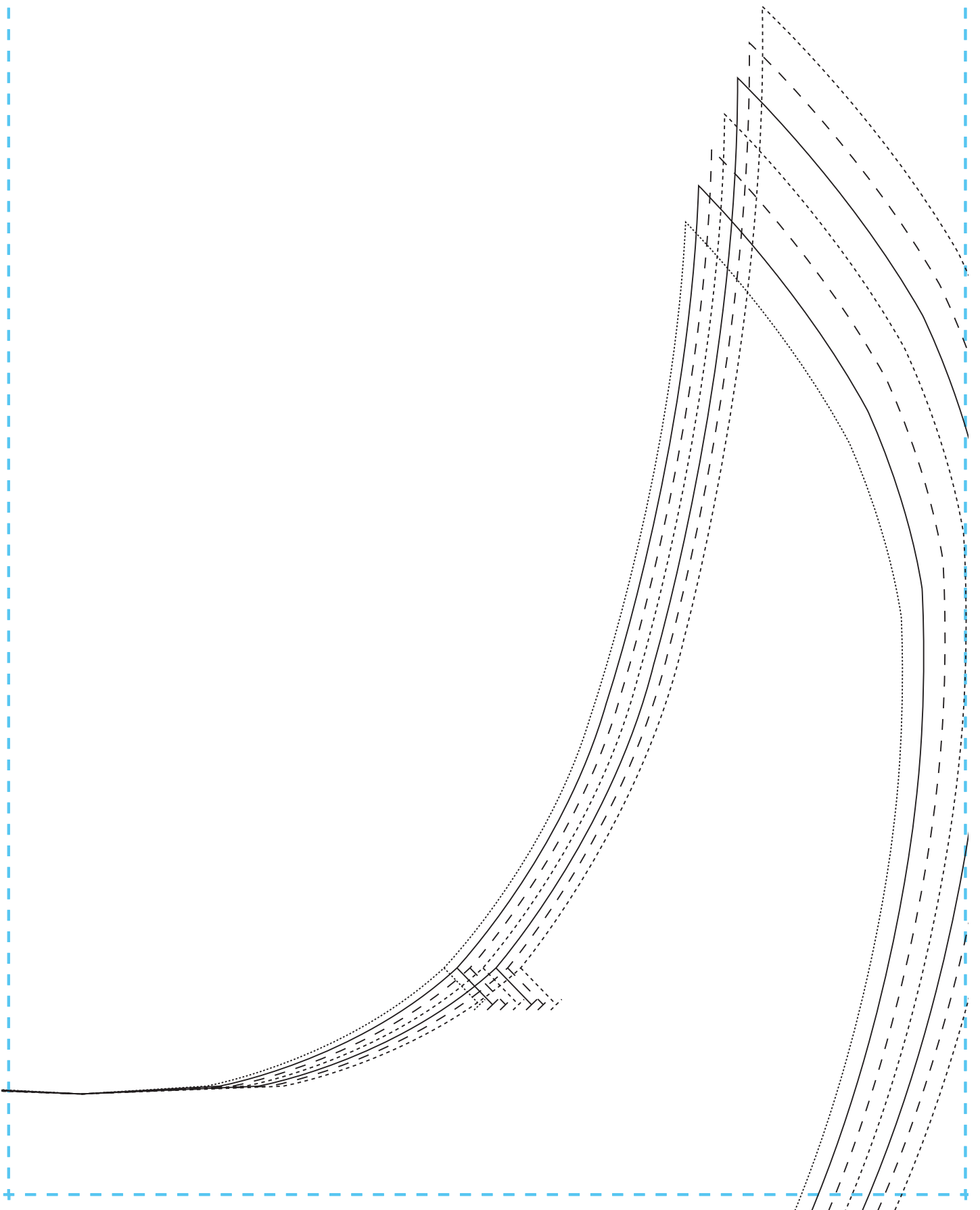

17

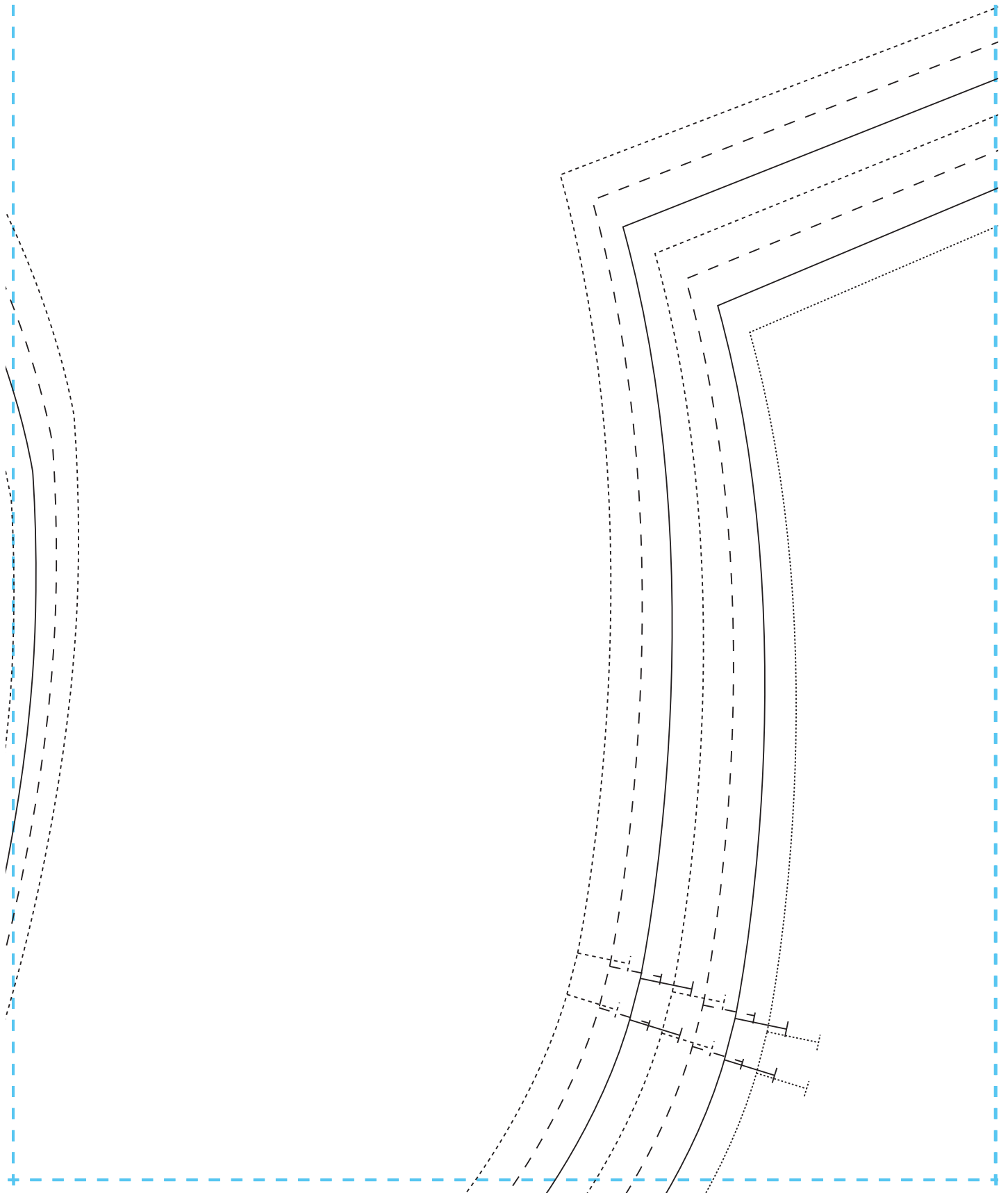

18

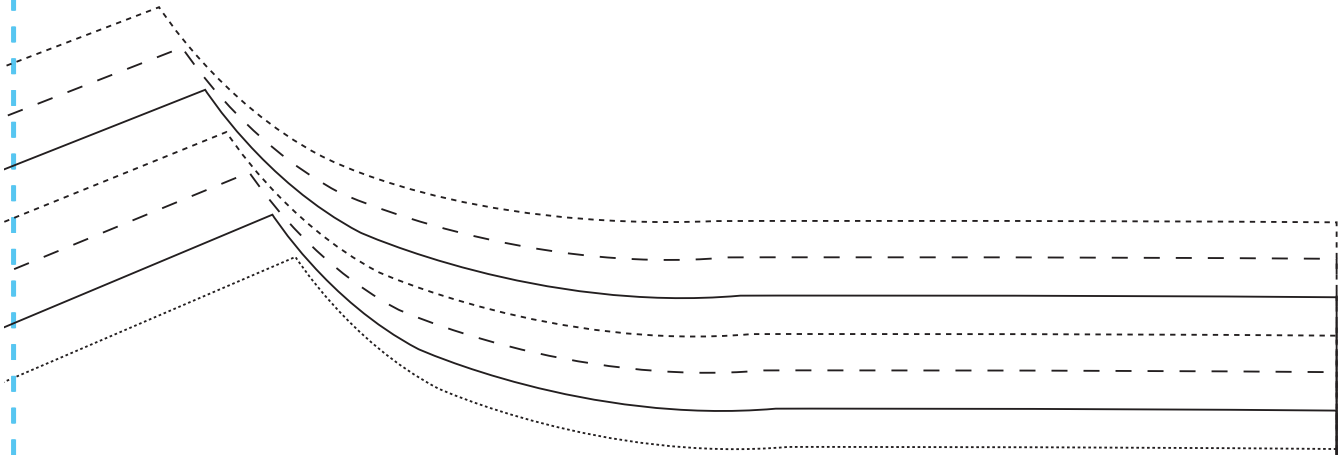

AMELIE TOP
BACK FACING
CUT ONE PAIR

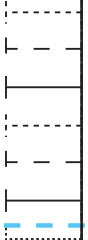

19

AMELIE TOP
FRILL
CUT TWO PAIRS

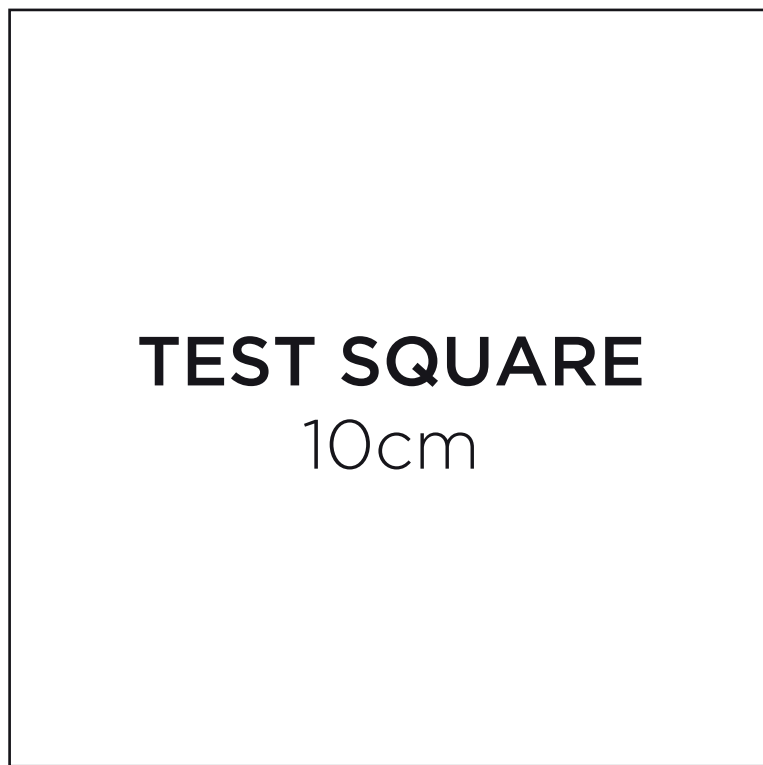
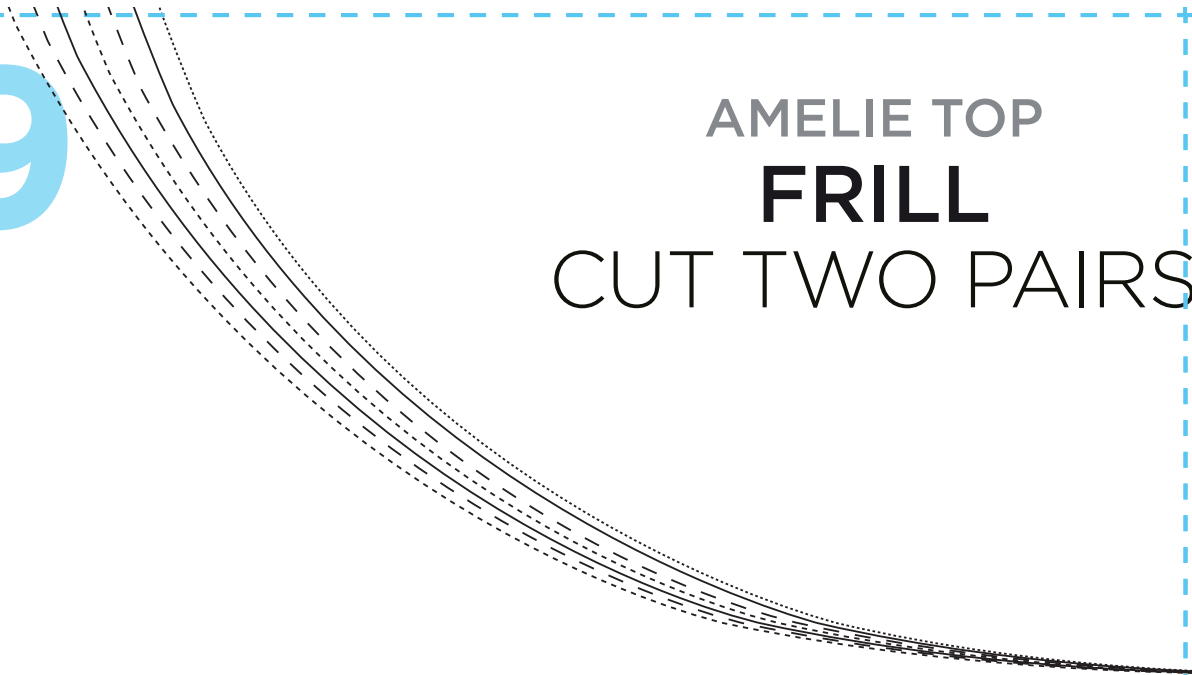

TEST SQUARE
10cm

20

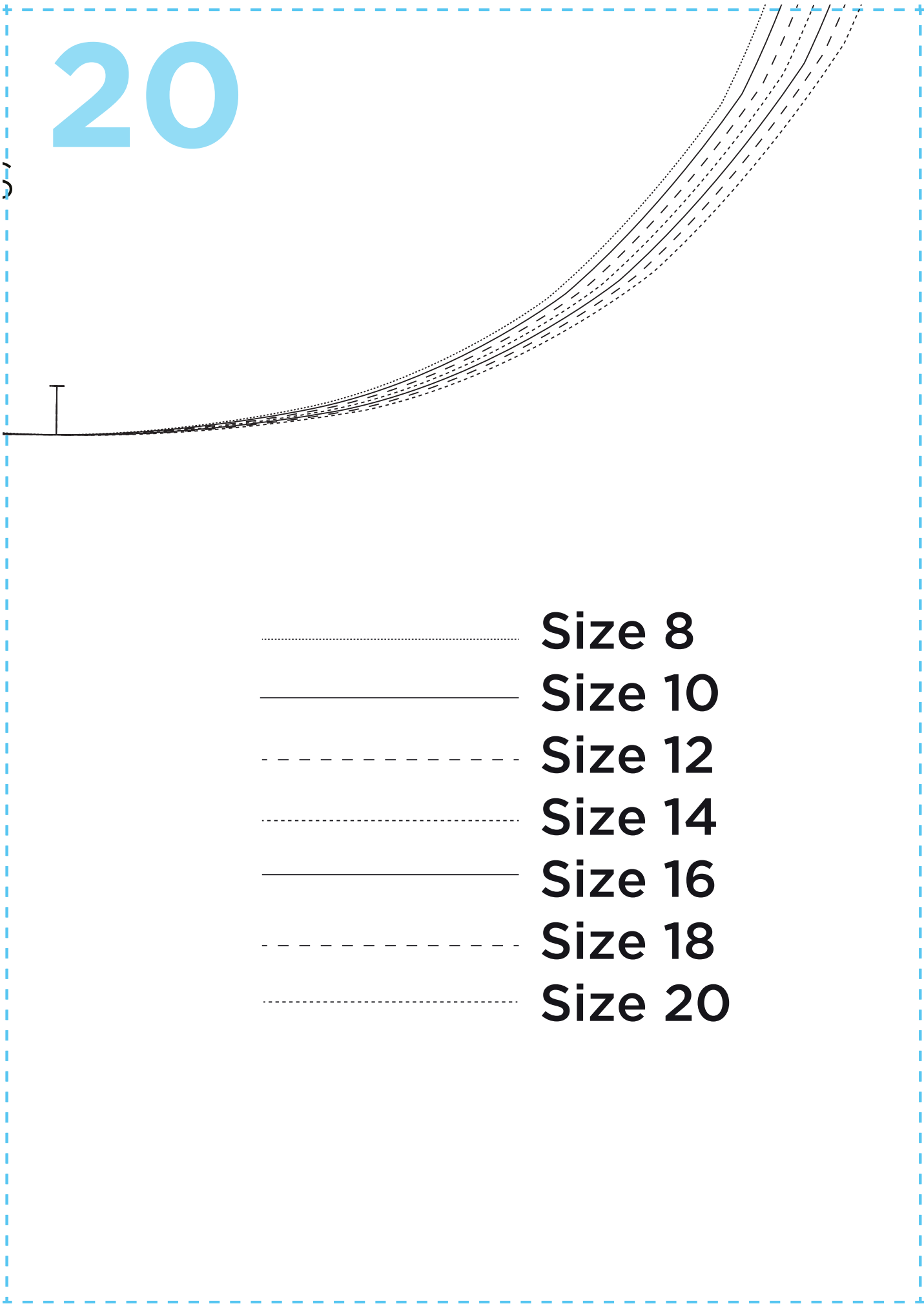

- Size 8
- Size 10
- - - - Size 12
- Size 14
- Size 16
- - - - Size 18
- Size 20

21

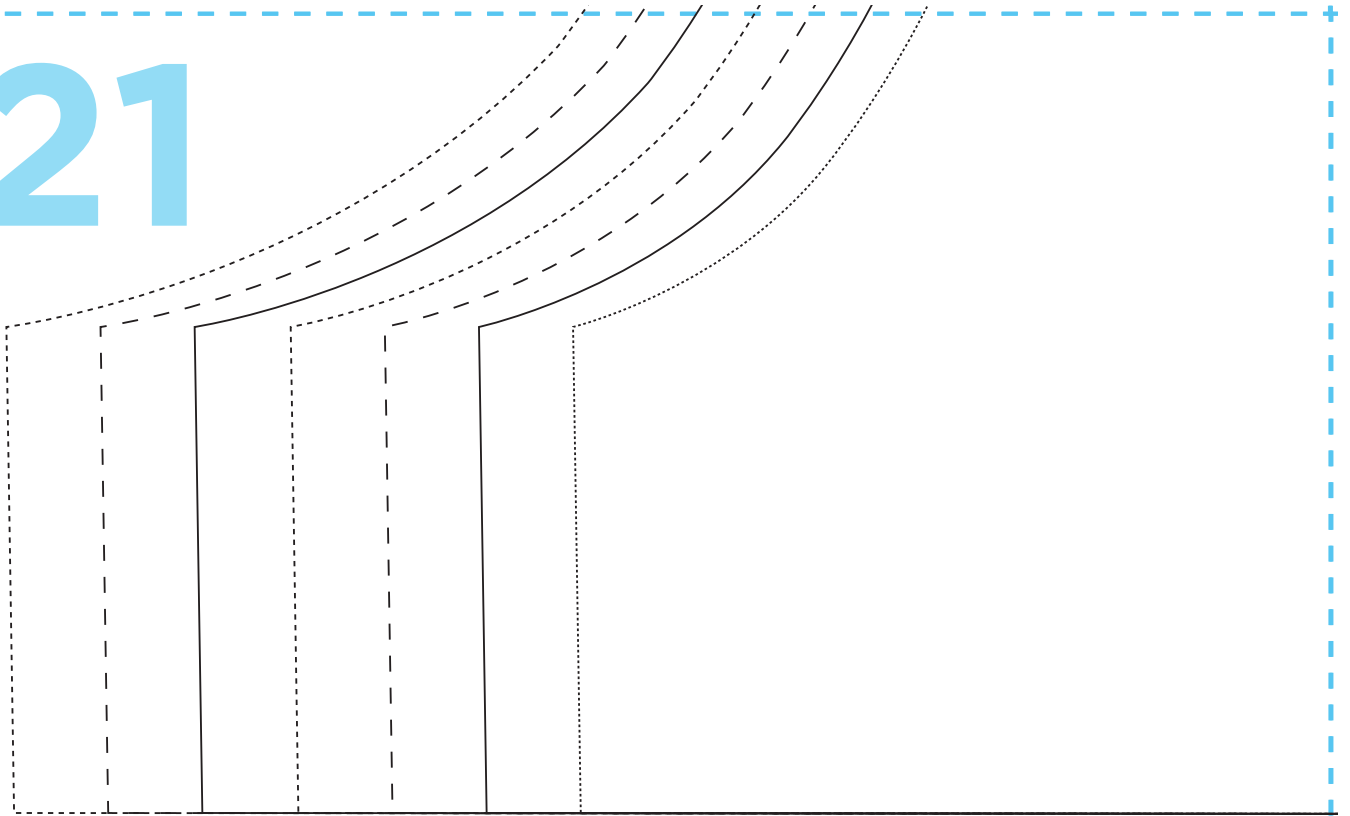

21

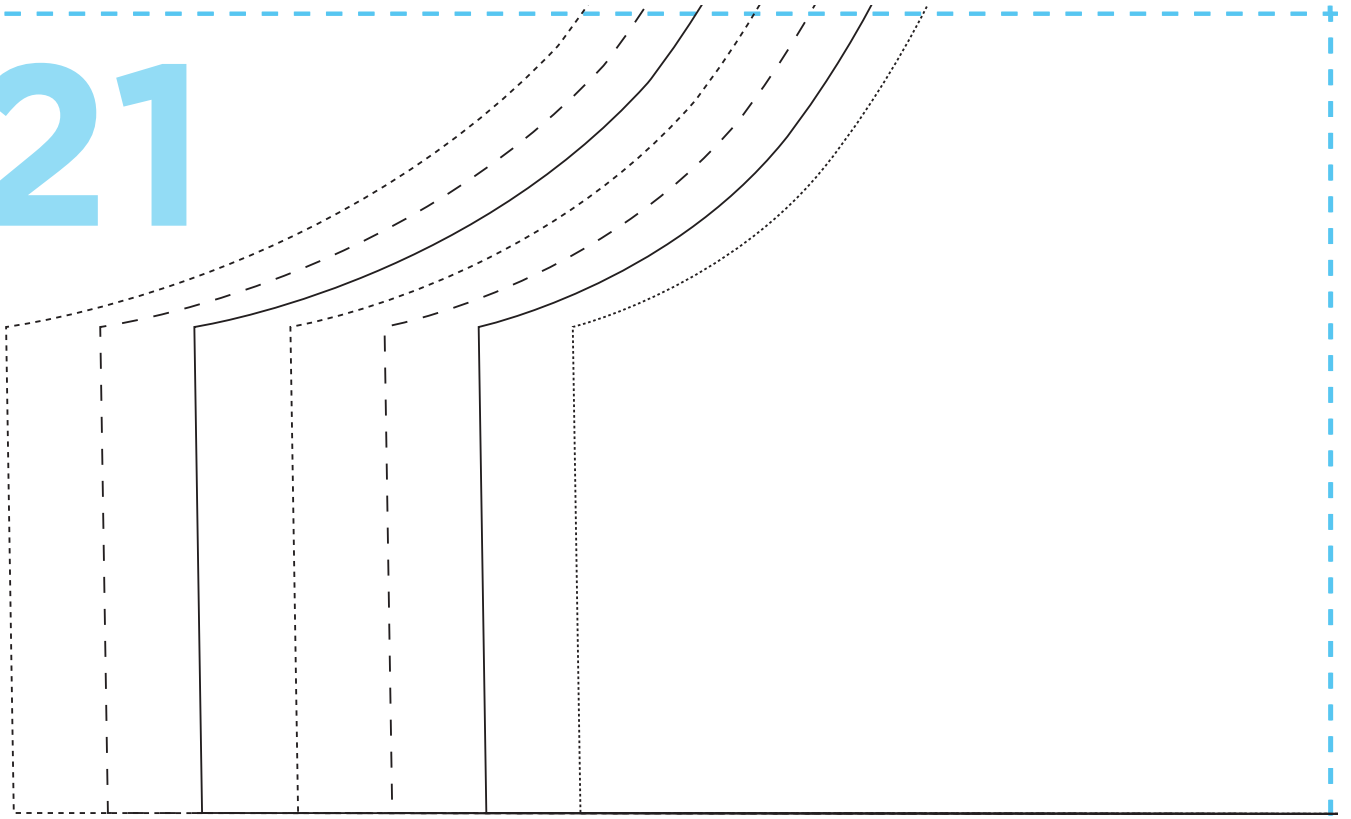

22